



PV Inverter

SUNNY BOY

3000TL-US / 3800TL-US / 4000TL-US /

5000TL-US / 6000TL-US / 7000TL-US / 7700TL-US

User Manual

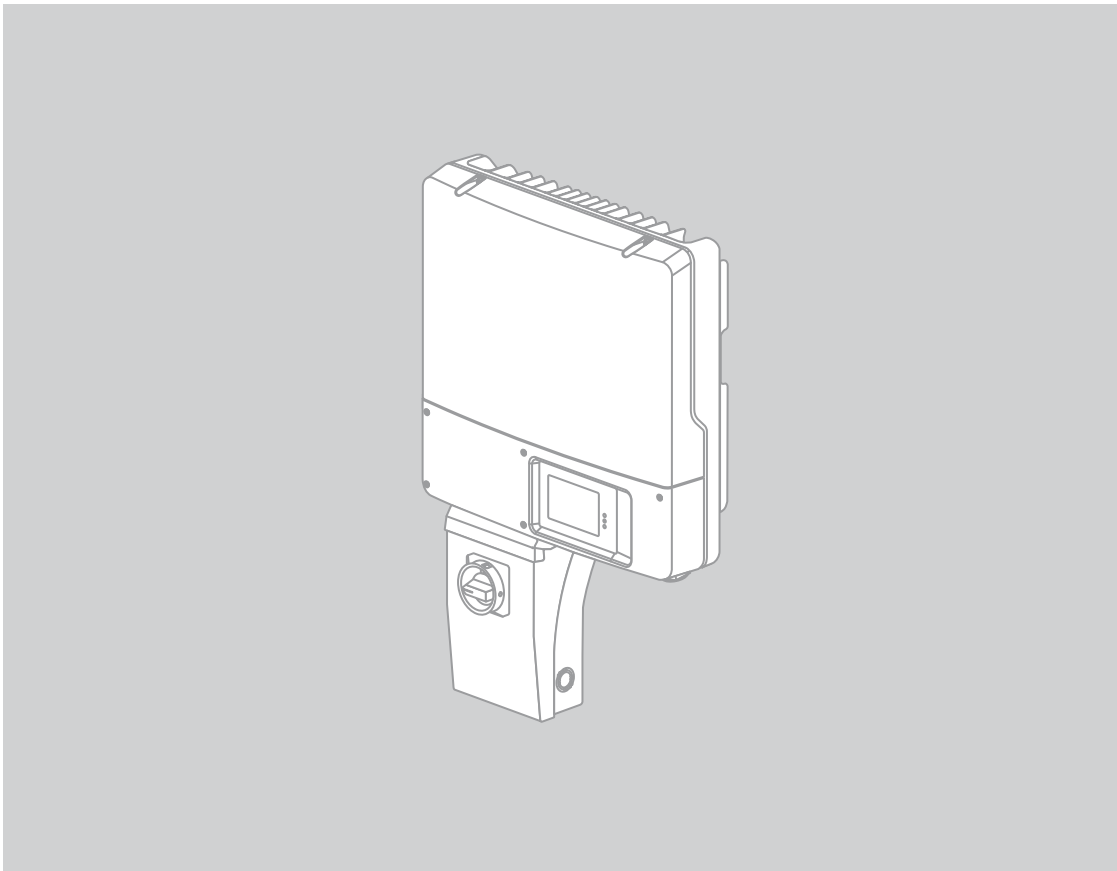

Legal Provisions

Copyright © 2014 SMA America, LLC. All rights reserved.

No part of this document may be reproduced, stored in a retrieval system, or transmitted, in any form or by any means, electronic, mechanical, photographic, magnetic or otherwise, without the prior written permission of SMA America, LLC.

Neither SMA America, LLC nor SMA Solar Technology Canada Inc. makes representations, express or implied, with respect to this documentation or any of the equipment and/or software it may describe, including (with no limitation) any implied warranties of utility, merchantability, or fitness for any particular purpose. All such warranties are expressly disclaimed. Neither SMA America, LLC nor its distributors or dealers nor SMA Solar Technology Canada Inc. nor its distributors or dealers shall be liable for any indirect, incidental, or consequential damages under any circumstances.

(The exclusion of implied warranties may not apply in all cases under some statutes, and thus the above exclusion may not apply.)

Specifications are subject to change without notice. Every attempt has been made to make this document complete, accurate and up-to-date. Readers are cautioned, however, that SMA America, LLC and SMA Solar Technology Canada Inc. reserve the right to make changes without notice and shall not be responsible for any damages, including indirect, incidental or consequential damages, caused by reliance on the material presented, including, but not limited to, omissions, typographical errors, arithmetical errors or listing errors in the content material.

All trademarks are recognized even if these are not marked separately. Missing designations do not mean that a product or brand is not a registered trademark.

SMA America, LLC
3801 N. Havana Street
Denver, CO 80239 U.S.A.

SMA Solar Technology Canada Inc.
2425 Matheson Blvd. E
7th Floor
Mississauga, ON L4W 5K4
Canada

IMPORTANT SAFETY INSTRUCTIONS

SAVE THESE INSTRUCTIONS

This manual contains important instructions for the following products:



- Sunny Boy 3000TL-US (SB 3000TL-US-22)
- Sunny Boy 3800TL-US (SB 3800TL-US-22)
- Sunny Boy 4000TL-US (SB 4000TL-US-22)
- Sunny Boy 5000TL-US (SB 5000TL-US-22)
- Sunny Boy 6000TL-US (SB 6000TL-US-22)
- Sunny Boy 7000TL-US (SB 7000TL-US-22)
- Sunny Boy 7700TL-US (SB 7700TL-US-22)

This manual must be followed during installation and maintenance.

The product is designed and tested according to international safety requirements, but as with all electrical and electronic equipment, certain precautions must be observed when installing and/or operating the product. To reduce the risk of personal injury and to ensure the safe installation and operation of the product, you must carefully read and follow all instructions, cautions and warnings in this manual.





Warnings in this document

A warning describes a hazard to equipment or personnel. It calls attention to a procedure or practice, which, if not correctly performed or adhered to, could result in damage to or destruction of part or all of the SMA equipment and/or other equipment connected to the SMA equipment or personal injury.

Symbol	Description
 DANGER	DANGER indicates a hazardous situation which, if not avoided, will result in death or serious injury.
 WARNING	WARNING indicates a hazardous situation which, if not avoided, could result in death or serious injury.
 CAUTION	CAUTION indicates a hazardous situation which, if not avoided, could result in minor or moderate injury.
NOTICE	NOTICE is used to address practices not related to personal injury.

Warnings on this product

The following symbols are used as product markings with the following meanings.

Symbol	Description
	Warning regarding dangerous voltage The product works with high voltages. All work on the product must only be performed as described in the documentation of the product.
	Beware of hot surface The product can become hot during operation. Do not touch the product during operation.
	Electric arc hazards The product has large electrical potential differences between its conductors. Arc flashes can occur through air when high-voltage current flows. Do not work on the product during operation.
	Risk of fire Improper installation of the product may cause a fire.
	Observe the operating instructions Read the documentation of the product before working on it. Follow all safety precautions and instructions as described in the documentation.

General Warnings

WARNING

General Warnings

All electrical installations must be made in accordance with the local and *National Electrical Code*[®] ANSI/NFPA 70 or the *Canadian Electrical Code*[®] CSA C22.1. This document does not and is not intended to replace any local, state, provincial, federal or national laws, regulation or codes applicable to the installation and use of the product, including without limitation applicable electrical safety codes. All installations must conform with the laws, regulations, codes and standards applicable in the jurisdiction of installation. SMA assumes no responsibility for the compliance or noncompliance with such laws or codes in connection with the installation of the product.

The product contains no user-serviceable parts.

For all repair and maintenance, always return the unit to an authorized SMA Service Center.

Before installing or using the product, read all of the instructions, cautions, and warnings in this manual.

Before connecting the product to the electrical utility grid, contact the local utility company. This connection must be made only by qualified personnel.

Wiring of the product must be made by qualified personnel only.

Table of Contents

1	Information on this Document	9
2	Safety	11
2.1	Intended Use	11
2.2	Safety Precautions	12
3	Product Description	13
3.1	Sunny Boy	13
3.2	Display	14
3.3	Type Labels	17
3.3.1	Sunny Boy	17
3.3.2	DC Disconnect	18
3.3.3	Symbols on the Type Labels	19
3.4	Communication Interface	19
3.5	Secure Power Supply (SPS)	20
3.6	Fan Retrofit Kit	20
3.7	Arc-Fault Circuit Interrupter (AFCI)	20
4	LED Signals	21
5	Secure Power Operation	22
6	The Message "Electr. arc detected" is displayed	23
7	Cleaning the Inverter	25
8	Glossary	25
9	Compliance Information	26
10	Contact	27

1 Information on this Document

Validity







This document is valid for the following device types from firmware version 2.10:

- Sunny Boy 3000TL-US (SB 3000TL-US-22)
- Sunny Boy 3800TL-US (SB 3800TL-US-22)
- Sunny Boy 4000TL-US (SB 4000TL-US-22)
- Sunny Boy 5000TL-US (SB 5000TL-US-22)
- Sunny Boy 6000TL-US (SB 6000TL-US-22)
- Sunny Boy 7000TL-US (SB 7000TL-US-22)
- Sunny Boy 7700TL-US (SB 7700TL-US-22)

Target Group

This document is intended for end users.

Symbols

Symbol	Explanation
 DANGER	Indicates a hazardous situation which, if not avoided, will result in death or serious injury
 WARNING	Indicates a hazardous situation which, if not avoided, can result in death or serious injury
 CAUTION	Indicates a hazardous situation which, if not avoided, can result in minor or moderate injury
 NOTICE	Indicates a situation which, if not avoided, could result in property damage
	Information that is important for a specific topic or goal, but is not safety-relevant
<input type="checkbox"/>	Indicates an essential requirement for achieving a specific goal
<input checked="" type="checkbox"/>	Desired result
	A problem that could occur

Nomenclature

Complete designation	Designation in this document
Sunny Boy	Inverter, product

Abbreviations

Abbreviation	Designation	Explanation
AC	Alternating Current	-
DC	Direct Current	-
LED	Light-Emitting Diode	-

2 Safety

2.1 Intended Use

The Sunny Boy is a transformerless PV inverter which converts the direct current of a PV array into grid-compliant alternating current and feeds it into the power distribution grid.

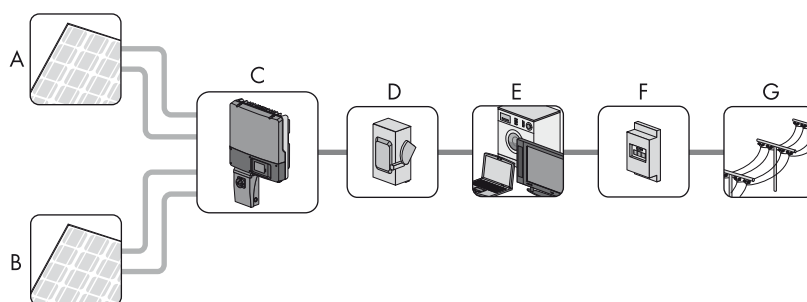

Figure 1: Design of a PV plant with a Sunny Boy

Position	Designation
A	PV modules input A
B	PV modules input B
C	Inverter with DC Disconnect
D	Miniature circuit-breaker
E	Loads
F	Electricity meter
G	Power distribution grid

The inverter is suitable for indoor and outdoor use.

Alternative uses of the Sunny Boy not expressly recommended by SMA are not permitted.

For safety reasons, it is not permitted to modify the product or install components that are not explicitly recommended or distributed by SMA for this product.

The enclosed documentation is an integral part of this product.

- Read and observe the documentation.
- Keep the documentation in a convenient place for future reference.

2.2 Safety Precautions

DANGER

Danger to life from electric shock due to high voltages in the inverter

High voltages that can cause fatal electric shocks are present in the live components of the inverter.

- Do not open the inverter.
- All work on the inverter (e.g. repairs, modifications) may only be carried out by a qualified person.

Danger to life from electric shock due to damaged devices

Operating a damaged inverter can lead to hazardous situations that result in death or serious injuries due to electric shock.

- Only operate the inverter if it is in safe and full working order.
- Check the inverter regularly for visible damage.
- Only operate the inverter if there is no visible damage.

CAUTION

Risk of burns from hot surfaces

The surface of the inverter can become very hot. Touching the surface can lead to burns.

- During operation, only touch the lower enclosure lid and do not place any objects on the enclosure. Placing objects on the enclosure can lead to power reductions due to overheating and therefore to yield losses.
- Observe the safety messages on the inverter.

NOTICE

Inverter damage

Overvoltage can destroy the inverter.

- If the display message **DC overvoltage - Disconnect generator** is shown, inform your installer **IMMEDIATELY**.

3 Product Description

3.1 Sunny Boy

The Sunny Boy is a transformerless PV inverter that converts the direct current of a PV array into grid-compliant alternating current and feeds this into the power distribution grid.

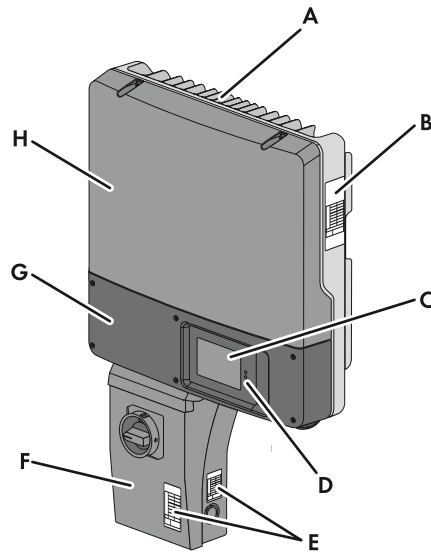

Figure 2: Sunny Boy design

Position	Designation
A	Cooling fins
B	Inverter type label
C	Display
D	LEDs
E	DC Disconnect type labels
F	DC Disconnect
G	Lower enclosure cover
H	Upper enclosure cover

Symbols on the Inverter

Symbol	Designation	Explanation
	Inverter	This symbol defines the function of the green LED. The green LED indicates the operating state of the inverter.
	Observe the documentation.	This symbol defines the function of the red LED. The red LED indicates an error. <ul style="list-style-type: none"> Contact your installer.
	Communication	This symbol defines the function of the blue LED. The blue LED indicates the communication state of the inverter.

3.2 Display

The display shows the current operating data of the inverter (e.g., current power, daily energy, total energy) as well as events or error messages. The power and energy are displayed as bars in the diagram.

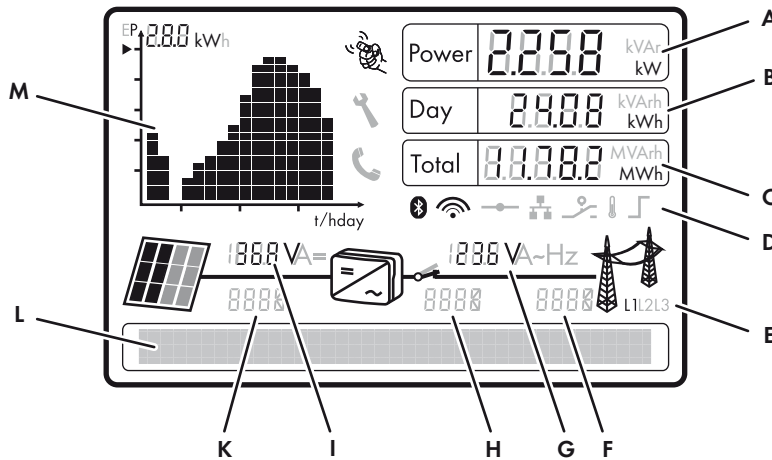













Figure 3: Display layout (example)

Item	Designation	Explanation
A	Power	Current power
B	Day	Daily energy
C	Total	Total amount of energy fed in until now

Item	Designation	Explanation
D	Active functions	Displays the activated or active functions for communication, network system services or temperature derating
E	Line conductor	Line conductor involved for the values displayed
F	Event number relating to the power distribution grid	Event number of errors relating to the power distribution grid
G	Output voltage/output current	Displays output voltage and output current of a line conductor in alternation
H	Event number relating to the inverter	Event number of errors relating to the inverter
I	Input voltage/input current	Displays input voltage and input current of one input in alternation
K	Event number relating to the PV plant	Event number of errors relating to the PV plant
L	Text line	Displays an event message or error message
M	Power and yield curve	Displays the power curve of the last 16 feed-in hours or the energy yield of the last 16 days <ul style="list-style-type: none"> In order to switch between the displays, tap once on the enclosure lid.

Symbols on the Display

Symbol	Designation	Explanation
	Tapping	You can operate the display by tapping it: <ul style="list-style-type: none"> Tapping once: to activate the backlight, to scroll to the next text line, to switch between the power graphs of the last 16 feed-in hours and the energy yields of the last 16 days. Tapping twice: the display shows, in succession, the firmware version, the serial number of the inverter, the NetID, the configured country data set and the display language.
	Telephone receiver	Indicates a fault that cannot be rectified on site <ul style="list-style-type: none"> Contact your installer.

Symbol	Designation	Explanation
	Wrench	Indicates a fault that can be rectified on site <ul style="list-style-type: none"> Contact your installer.
	Speedwire connection	Indicates that communication via Speedwire is active and there is a network connection
	Webconnect function	Indicates that there is a connection to Sunny Portal
	Multi-function relay	Indicates that the multi-function relay is activated
	Temperature symbol	Indicates that the power of the inverter is limited due to excessive temperature
	Power limitation	Indicates that external active power limitation via the Power Reducer Box is active
	PV array	-
	Inverter	-
	Grid relay	Grid relay closed: indicates that the inverter is feeding into the power distribution grid Grid relay open: indicates that the inverter is disconnected from the power distribution grid
	Power distribution grid	-

3.3 Type Labels

3.3.1 Sunny Boy

The type label provides a unique identification of the inverter. The type label is on the right-hand side of the enclosure.

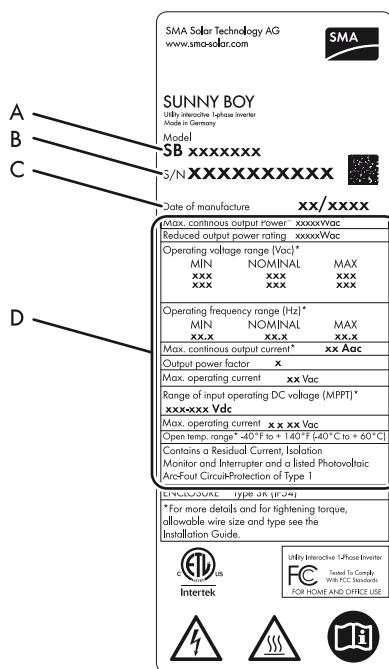

Figure 4: Layout of the type label

Position	Designation	Explanation
A	Model	Inverter device type
B	S/N	Inverter serial number
C	Date of manufacture	Inverter manufacture date (month/year)
D	Device-specific characteristics	-

You will require the information on the type label to use the inverter safely and when seeking customer support from the SMA Service Line. The type label must be permanently affixed to the inverter.

3.3.2 DC Disconnect

The type label provides a unique identification of the DC Disconnect. The type label is on the right-hand side of the enclosure.

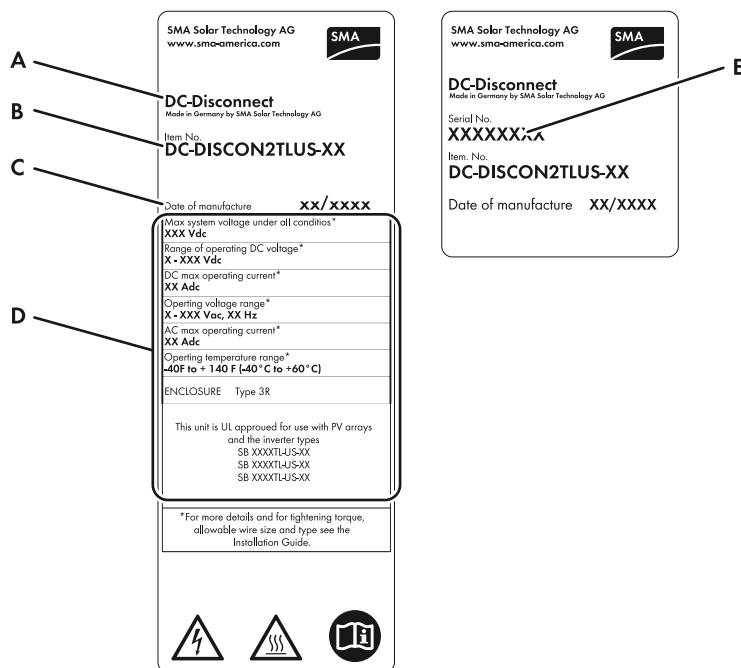







Figure 5: Layout of the type label

Position	Designation	Explanation
A	Product name	-
B	Item No.	DC Disconnect device type
C	Date of manufacture	DC Disconnect manufacture date (month/year)
D	Device-specific characteristics	-
E	Serial No.	DC Disconnect serial number

You will require the information on the type label to use the DC Disconnect safely and when seeking customer support from the SMA Service Line. The type label must be permanently affixed to the DC Disconnect.

3.3.3 Symbols on the Type Labels

Symbol	Designation	Explanation
	Danger to life due to high voltages	The product operates at high voltages. All work on the inverter must be carried out by qualified persons only.
	Risk of burns from hot surfaces	The product can become hot during operation. Avoid contact during operation. Allow the product to cool down sufficiently before carrying out any work. Wear personal protective equipment such as safety gloves.
	Observe the documentation.	Observe all documentation that is supplied with the product.
	ETL seal of approval	The product has been certified as being in accordance with the applicable directives by ETL.
	FCC seal of approval	The product complies with the requirements of the applicable FCC standards.

3.4 Communication Interface

The inverter can be fitted with an extra communication interface (e.g., RS485 or Speedwire with Webconnect function). This communication interface enables the inverter to communicate with special SMA communication products or other inverters (for information on supported products, see www.SMA-Solar.com). The interface can be retrofitted, installed at the factory if specified in the order or included in the scope of delivery.

You can only set the inverter parameters via SMA communication products.

Depending on the type of communication, RS485 or Speedwire, the parameters and messages are displayed differently on the communication products.

Example: Displaying the country data set parameter

For communication via RS485: **CntrySet** parameter

For communication via Speedwire: **Set country standard** parameter

You can set the country data set of the inverter before commissioning or within the first ten operating hours via the two rotary switches in the inverter. You can only set all other operating parameters of the inverter via communication products.

3.5 Secure Power Supply (SPS)

The inverter is equipped with a secure power supply by means of which an external socket-outlet can be connected to the inverter. The socket-outlet provides current from the PV plant on demand in the event of a grid failure (see Section 5 "Secure Power Operation", page 22). The secure power supply also has a terminal for the fan retrofit kit, enabling an external fan to be controlled.

3.6 Fan Retrofit Kit

The fan retrofit kit is used for additional inverter cooling at high ambient temperatures (for information on installation and configuration, see the fan retrofit kit installation manual). The fan retrofit kit can be retrofitted, installed at the factory if specified in the order or included in the scope of delivery.

The Sunny Boy 6000TL-US, 7000TL-US and 7700TL-US are equipped with a fan as standard.

3.7 Arc-Fault Circuit Interrupter (AFCI)

In accordance with the *National Electrical Code*[®], Article 690.11, the inverter has a system for the recognition of electric arc detection and interruption. An electric arc with a power of 300 W or greater must be interrupted by the AFCI within the time specified by UL 1699B. A tripped AFCI can only be reset manually. You can deactivate the automatic arc fault detection and interruption (AFCI) via a communication product in "Installer" mode if you do not require this function. The 2011 edition of the *National Electrical Code*[®], Section 690.11 stipulates that newly installed PV systems attached to a building must be fitted with a means of detecting and disconnecting serial electric arcs (AFCI) on the PV side.

4 LED Signals

The LEDs indicate the operating state of the inverter.

Designation	Status	Explanation
Green LED	Is lit	Operation
	Flashing	Requirements for connection to the power distribution grid have not been met.
Red LED	Is lit	Error <ul style="list-style-type: none">Contact your installer.
Blue LED	Is lit	Communication is activated.

5 Secure Power Operation

If the inverter has a secure power supply, you can use the energy from the PV plant directly via the connected socket-outlet in the event of a grid failure. The inverter automatically regulates the energy supply of the secure power socket-outlet according to the solar irradiation on the PV plant. While the secure power socket-outlet is in use, the inverter is disconnected from the grid and does therefore not feed into the power distribution grid. The secure power socket-outlet can not be used over-night, because there is no solar irradiation available for the supply of the socket-outlet.

i Do not connect any devices that require a stable electricity supply

The power available during secure power operation depends on the solar irradiation on the PV modules. Therefore, the power can fluctuate considerably depending on the weather or may not be available at all. In the event of solar irradiation being too low or overload of the socket-outlet, the voltage supply of the secure socket-outlet will also be interrupted. 20 seconds after interruption, re-establishment of the voltage supply will be attempted automatically. This can lead to the inadvertent starting of the connected loads.

- Do not operate any devices via the secure power socket-outlet that are dependent on a stable electricity supply for their reliable operation.
- Ensure that the loads that are connected to the secure power socket-outlet do not require more than 1,500 W.

Requirements

- The inverter must be showing the error message 202, 203, 204, 205 or 801.
- There must be sufficient solar irradiation.
- Load with a maximum power of 1,500 W

Procedure for the secure power operation

1. Switch off the inverter miniature circuit-breaker.
2. Switch on the socket-outlet.
3. Plug in the load.
4. Switch on the load.

i Disconnection of the inverter due to insufficient irradiation

When the inverter disconnects itself due to insufficient irradiation, you have to switch back on the socket-outlet as soon as irradiation is sufficient.

Procedure once the power distribution grid becomes available again

If the power distribution grid becomes available again during secure power operation, the inverter remains in secure power operation. The inverter only starts to feed in to the power distribution grid again once the load has been disconnected and the miniature circuit-breaker is switched back on.

1. Disconnect the load.
2. Remove the plug for the load from the secure power socket-outlet.
3. Switch off the secure power socket-outlet so that the inverter begins feeding into the power distribution grid again.
4. Switch the inverter miniature circuit-breaker back on.

6 The Message "Electr. arc detected" is displayed

- ✘ An electric arc occurred in the PV system.
- ✘ The red LED is permanently lit.
- ✘ The AFCI has tripped and the inverter is in permanent shutdown.

⚠ CAUTION**Danger of fire from electric arc**

- Only test the AFCI for false tripping in the order described below.
- Do not deactivate the AFCI permanently.

1. If the following message appears on the display, tap on the enclosure lid: **Electr. arc detected. Please confirm by tapping.**

 **The message "Electr. arc detected. Please confirm by tapping." appears for 10 seconds only. After this, it is no longer possible to restart the unit by tapping on the enclosure lid.**

- Contact the SMA Service Line. See Section 10.
- or**
- Access the user interface of the communication product.
- Reset the operation inhibition by setting one of the following parameters:
Select the parameter **Reset operating data** or **Op.FncSetlstl** and set to **Reset operation inhibition** or **RSPermStopOp**. This effects resetting of the operation inhibition.
- or**
- Select the parameter **AFCI switched on** or **AfcilsOn** and set to **No** and then back to **Yes**. This effects resetting of the operation inhibition.

- If the AFCI self-test is successful, the green LED is lit and the display shows the device type, the firmware version, the device names, the country data set and display language. If communication is via Speedwire, then the status and the versions of the communication assemblies will also be displayed also after the device names.

The inverter feeds into the grid.

✘ Green LED flashing?

Possible cause of error: The DC input voltage is still too low, or the inverter is monitoring the utility grid.

- Once the DC input voltage is sufficiently high, the inverter goes into operation.

✘ The red LED is lit and an error message and event number appear in the display?

- Contact the SMA Service Line. See Section 10.

✘ The blue LED is glowing or flashing?

- Eliminate the communication error (Contact the SMA Service Line. See Section 10).

- ✘** If the AFCI self-test fails the inverter repeats the AFCI self-test until it is successful.

- ✘** If the AFCI self-test continues to fail Contact the SMA Service Line. See Section 10.

7 Cleaning the Inverter

NOTICE**Damage to the display due to the use of cleaning agents**

- If the inverter is dirty, clean the enclosure lid, the display, and the LEDs using only clean water and a cloth.

8 Glossary

Energy

Energy is the power that a system can supply or consume within a certain unit of time. Energy is measured in Wh (watt hours). If your inverter feeds in for half an hour at 3,000 W and for half an hour at 2,000 W, it will have fed in a total of 2,500 Wh.

Power

Power is the product of the voltage and electrical current strength. Power is measured in W (watts). The power shown in the display is an instantaneous value. It indicates the power that your inverter is currently feeding into the power distribution grid.

9 Compliance Information

FCC Compliance

This device complies with Part 15 of the FCC Rules. Operation is subject to the following conditions:

1. This device must not cause harmful interference, and
2. This device must accept any interference received, including interference that may cause undesired operation.

NOTE: This equipment has been tested and found to comply with the limits for a Class B digital device, pursuant to Part 15 of the FCC Rules. These limits are designed to provide reasonable protection against harmful interference in a residential installation. This equipment generates, uses, and can radiate radio frequency energy and, if not installed and used in accordance with the instructions, may cause harmful interference to radio communications. However, there is no guarantee that interference will not occur in a particular installation. If this equipment does cause harmful interference to radio or television reception, which can be determined by turning the equipment off and on, the user is encouraged to try to correct the interference by one or more of the following measures:

- Reorient or relocate the receiving antenna.
- Increase the distance between the equipment and the receiver.
- Connect the equipment into an outlet on a circuit different from that to which the receiver is connected.
- Consult the dealer or an experienced radio/TV technician for help.
- The user is cautioned that changes or modifications not expressly approved by SMA America, Inc. could void the user's authority to operate this equipment.

IC Compliance

This Class B digital apparatus complies with Canadian ICES-003.

Cet appareil numérique de la classe B est conforme à la norme NMB-003 du Canada.

Operation is subject to the following two conditions:

- This device must not cause interference, and
- This device must accept any interference, including interferences that may cause undesired operation of the device.

10 Contact

If you have technical problems, first contact your installer. The following information is required in order to provide you with the necessary assistance:

- Inverter device type
- Inverter serial number
- Inverter firmware version
- Special country-specific settings of the inverter
- Type and number of PV modules connected
- Mounting location and mounting altitude of the inverter
- Three-digit or four-digit event number and display message of the inverter
- Optional equipment, e.g., communication products

United States/ Estados Unidos	SMA America, LLC Rocklin, CA	+1 877-MY-SMATech (+1 877-697-6283)* +1 916 625-0870**
Canada/ Canadá	SMA Canada, Inc. Toronto	+1 877-MY-SMATech (+1 877-697-6283)***

* toll free for USA, Canada and Puerto Rico / Exento de tasas en EE. UU., Canadá y Puerto Rico

** international / Internacional

*** toll free for Canada / gratuit pour le Canada

SMA Solar Technology

www.SMA-Solar.com

SMA America, LLC
www.SMA-America.com

