



FXR Series Inverter/Charger

FXR2012A

FXR2524A

FXR3048A

VFXR2812A

VFXR3524A

VFXR3648A



Installation Manual





About OutBack Power Technologies

OutBack Power Technologies is a leader in advanced energy conversion technology. OutBack products include true sine wave inverterchargers, maximum power point tracking charge controllers, and system communication components, as well as circuit breakers, batteries, accessories, and assembled systems.

Applicability

These instructions apply to OutBack inverter/charger models FXR2012A, FXR2524A, FXR3048A, VFXR2812A, VFXR3524A, and VFXR3648A only.

Contact Information

Address:	Corporate Headquarters 17825 – 59 th Avenue N.E. Suite B Arlington, WA 98223 USA	European Office Hansastraße 8 D-91126 Schwabach, Germany
Telephone:	+1.360.435.6030 +1.360.618.4363 (Technical Support) +1.360.435.6019 (Fax)	+49.9122.79889.0 +49.9122.79889.21 (Fax)
Email:	Support@outbackpower.com	
Website:	http://www.outbackpower.com	

Disclaimer

UNLESS SPECIFICALLY AGREED TO IN WRITING, OUTBACK POWER TECHNOLOGIES:

(a) MAKES NO WARRANTY AS TO THE ACCURACY, SUFFICIENCY OR SUITABILITY OF ANY TECHNICAL OR OTHER INFORMATION PROVIDED IN ITS MANUALS OR OTHER DOCUMENTATION.

(b) ASSUMES NO RESPONSIBILITY OR LIABILITY FOR LOSS OR DAMAGE, WHETHER DIRECT, INDIRECT, CONSEQUENTIAL OR INCIDENTAL, WHICH MIGHT ARISE OUT OF THE USE OF SUCH INFORMATION. THE USE OF ANY SUCH INFORMATION WILL BE ENTIRELY AT THE USER'S RISK.

OutBack Power Technologies cannot be responsible for system failure, damages, or injury resulting from improper installation of their products.

Information included in this manual is subject to change without notice.

Notice of Copyright

FXR Series Inverter/Charger Installation Manual © 2015 by OutBack Power Technologies. All Rights Reserved.

Trademarks

OutBack Power, the OutBack Power logo, FLEXPowER ONE, Grid/Hybrid, and OPTICS RE are trademarks owned and used by OutBack Power Technologies, Inc. The ALPHA logo and the phrase "member of the Alpha Group" are trademarks owned and used by Alpha Technologies Inc. These trademarks may be registered in the United States and other countries.

Date and Revision

September 2015, Revision B

Part Number

900-0166-01-00 Rev B



Table of Contents

Introduction	5
Audience	5
Welcome to OutBack Power Technologies.....	5
Models	6
Inverter Model Names	6
Components and Accessories	6
Planning	9
Applications	9
Input Modes.....	10
Renewable Energy.....	10
Battery Bank.....	11
Generator.....	13
Installation	15
Location and Environmental Requirements.....	15
Tools Required.....	15
Mounting.....	16
Dimensions.....	16
Terminals and Ports.....	17
Wiring	18
Grounding	18
DC Wiring	20
AC Wiring.....	23
AC Sources.....	24
ON and OFF Wiring	25
Accessory Wiring.....	25
AUX Wiring	26
Generator Control.....	27
AC Configurations.....	29
Single-Inverter.....	29
Multiple-Inverter AC Installations (Stacking).....	30
Stacking Configurations	31
Commissioning	41
Functional Test.....	41
Pre-startup Procedures	41
Startup	41
Powering Down.....	43
Adding New Devices.....	43
Firmware Updates.....	44
Operation	44
Definitions.....	45
Symbols Used	46
Index	47

List of Tables

Table 1	Models.....	6
Table 2	Components and Accessories	6
Table 3	Battery Bank Elements.....	12
Table 4	Ground Conductor Size and Torque Requirements	18
Table 5	DC Conductor Size and Torque Requirements.....	20
Table 6	Terms and Definitions	45

List of Figures

Figure 1	FXR Series Inverter/Charger	5
Figure 2	Components	7
Figure 3	Applications (Example)	9
Figure 4	Dimensions.....	16
Figure 5	Terminals, Ports, and Features.....	17
Figure 6	DC Ground Lug	19
Figure 7	Chassis Ground/PE.....	19
Figure 8	Required Order of Battery Cable Hardware	21
Figure 9	Battery Terminal Covers.....	21
Figure 10	DC Cover Attachment.....	22
Figure 11	Turbo Fan Wiring.....	22
Figure 12	AC Terminals	23
Figure 13	AC Sources	24
Figure 14	AC Sources and Transfer Relay	24
Figure 15	ON/OFF Jumper and Connections	25
Figure 16	Accessory Connections	25
Figure 17	AUX Connections for Vent Fan (Example).....	26
Figure 18	AUX Connections for Diversion (Example).....	26
Figure 19	Two-Wire Generator Start (Example)	27
Figure 20	Three-Wire Generator Start (Example)	28
Figure 21	Single-Inverter Wiring.....	29
Figure 22	OutBack HUB10.3 and MATE3	30
Figure 23	Example of Series Stacking Arrangement	31
Figure 24	Series Wiring (Two Inverters)	32
Figure 25	Example of Parallel Stacking Arrangement (Three Inverters)	33
Figure 26	Parallel Wiring (Four Inverters).....	34
Figure 27	Example of Series/Parallel Stacking Arrangement (Four Inverters)	35
Figure 28	Series/Parallel Wiring	36
Figure 29	Example of Three-Phase Stacking Arrangement (Three Inverters)	37
Figure 30	Example of Three-Phase Stacking Arrangement (Nine Inverters)	37
Figure 31	Three-Phase Wiring (Three Inverters)	39
Figure 32	AC Terminals	42



Introduction

Audience

This book provides instructions for the physical installation and wiring of this product. These instructions are for use by qualified personnel who meet all local and governmental code requirements for licensing and training for the installation of electrical power systems with AC and DC voltage up to 600 volts. This product is only serviceable by qualified personnel.

Welcome to OutBack Power Technologies

Thank you for purchasing the OutBack FXR Series Inverter/Charger. This product offers a complete power conversion system between batteries and AC power. It can provide backup power, sell power back to the utility grid, or provide complete stand-alone off-grid service.

- 12-, 24-, and 48-volt models
- Output power from 2.0 kVA to 3.6 kVA
- Designed to be integrated as part of an OutBack Grid/Hybrid™ system using FLEXware™ components
- Battery-to-AC inverting with single-phase adjustable output for such standards as 120 Vac, 100 Vac, or 127 Vac (at 60 or 50 Hz)
- AC-to-battery charging (FXR systems are battery-based)
- Uses battery energy stored from renewable resources
 - ~ Can utilize stored energy from PV arrays, wind turbines, etc.
 - ~ OutBack FLEXmax charge controllers will optimize PV output
- Inverter load support for a small AC source
- Sell-back to utility (grid-interactive function)
 - ~ Available in 24- and 48-volt models
- Rapid transfer between AC source and inverter output with minimal delay time
- Uses the MATE3™ System Display and Controller or the AXS Port™ SunSpec Modbus Interface (sold separately) for user interface as part of a Grid/Hybrid system
- Supports the OPTICS RE™ online tool¹ for a cloud-based remote monitoring and control application
 - ~ Requires the MATE3 or the AXS Port
 - ~ Visit www.outbackpower.com to download
- Uses the HUB10.3™ Communications Manager for stacking as part of a Grid/Hybrid system
 - ~ Stackable in series, parallel, series/parallel, and three-phase configurations
- Listed to UL 1741 (2nd Edition) and CSA 22.2 by ETL



Figure 1 FXR Series Inverter/Charger

NOTE: This product has a settable AC output range. In this manual, many references to the output refer to the entire range. However, some references are made to 120 Vac or 60 Hz output. These are intended as examples only.

¹Outback Power Technologies Intuitive Control System for Renewable Energy
900-0166-01-00 Rev B

Models

Vented FXR (VFXR) models are intended for indoor or protected installation only. Vented inverters have an internal fan and use outside air for cooling. On average, the power of the vented models is rated higher than sealed models due to their greater cooling capabilities.

Sealed FXR models are designed for harsher environments and can survive casual exposure to the elements. However, enclosed protection is still recommended. (See page 15.) Sealed inverters have an internal fan, but do not use outside air for cooling. To compensate, sealed models are also equipped with the OutBack Turbo Fan assembly, using external air to remove heat from the chassis. (Vented models are not equipped with the Turbo Fan and cannot use it.)

Table 1 Models

Model	Type	Power	Battery	Application
FXR2012A	Sealed	2.0 kVA	12 Vdc	Off-grid, backup
VFXR2812A	Vented	2.8 kVA	12 Vdc	Off-grid, backup
FXR2524A	Sealed	2.5 kVA	24 Vdc	Off-grid, backup, grid-interactive
VFXR3524A	Vented	3.5 kVA	24 Vdc	Off-grid, backup, grid-interactive
FXR3048A	Sealed	3.0 kVA	48 Vdc	Off-grid, backup, grid-interactive
VFXR3648A	Vented	3.6 kVA	48 Vdc	Off-grid, backup, grid-interactive

Inverter Model Names

FXR series model numbers use the following naming conventions.

- The model number includes “FXR” as the inverter series. “R” indicates that the FXR was designed for renewable applications. Off-grid and grid-interactive functions are integrated in the same inverter.
- Vented models are preceded with “V”, as in “VFXR3648A”. If a model number does not begin with “V”, it is a sealed model and is equipped with a Turbo Fan. This is not indicated otherwise.
- The first two digits show the power of that model. For example, “FXR2012A” is 2000 watts.
- The second pair of digits shows the inverter’s nominal DC voltage. For example, “FXR2524A” is 24 volts.
- The model number is followed by “A”. This designates the inverter’s output as nominally 120 Vac (used in North America, Latin America, Asia, and other regions).

Components and Accessories

Table 2 Components and Accessories

Components to be Installed	Accessories Included
Battery Terminal Cover, red	FXR Inverter/Charger Installation Manual (this book)
Battery Terminal Cover, black	FXR Inverter/Charger Operator’s Manual
AC Plate	“WARNING ELECTRICAL SHOCK” sticker
DC Cover (DCC) or Turbo Fan	Silicone Grease Packet
Remote Temperature Sensor (RTS)	

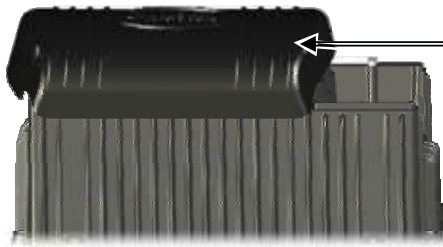

DCC (DC Cover)

This covers the DC terminal area on vented inverters. The DCC provides space to mount other components such as a DC current shunt.

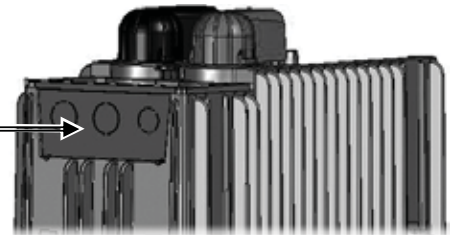

AC Plate

This plate is used for installations which do not utilize OutBack's optional FLEXware conduit boxes. The knockouts are used to install strain relief for flexible cable.

NOTE: This plate is not to be connected to conduit.

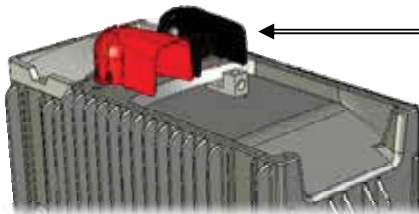

Battery Terminal Cover

These protect the terminals from accidental contact. They are made of stiff plastic with a snap-on design.

Always keep covers installed during normal operation.

Turbo Fan Cover

Included in place of the DCC on sealed inverters. Convectively cools chassis with the external OutBack Turbo Fan to allow maximum power.

NOTE: Do not install the Turbo Fan on a vented inverter.



NOTE: The DC Cover or Turbo Fan does not replace the battery terminal covers. These covers must be installed in addition to the DCC or fan.

Figure 2 Components



Planning

Applications

OutBack inverter/chargers are designed to use a battery bank to store energy. They work together with power from the utility grid or from renewable energy sources, such as photovoltaic (PV) modules, wind turbines, and other renewable sources. These sources charge the battery, which in turn is used by the inverter.

FXR series inverters have been designed to work with all types of renewable systems. These include off-grid, backup, and grid-interactive applications. The inverter's settings can be changed to accommodate many applications. Changes are made with the system display. 

The FXR inverter has one set of terminals for a single AC source. However, it can use two different AC sources when an external transfer switch is installed. The inverter can be independently programmed for each source. It is common to use utility grid power and a gas or diesel generator. Other combinations of AC sources are possible.

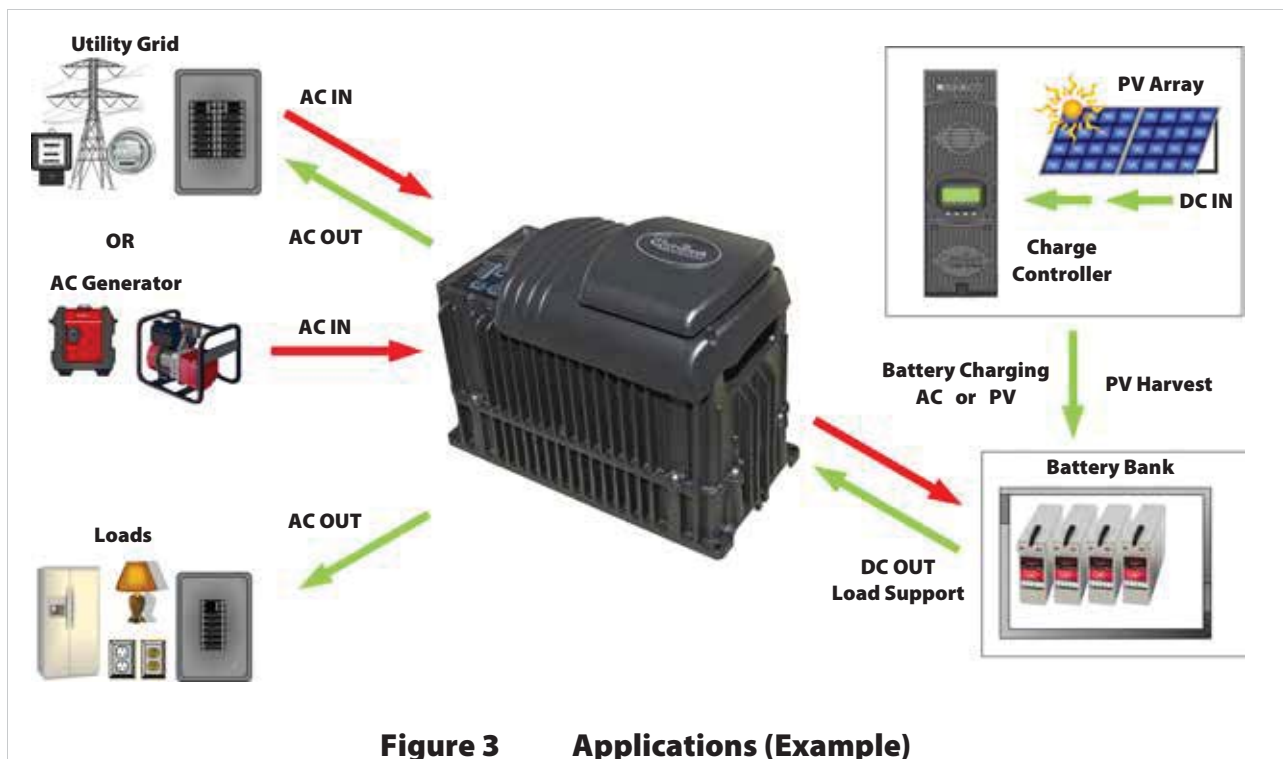

Figure 3 Applications (Example)

In Figure 3, the inverter uses a bidirectional AC input to sell power back to the utility grid. The power being delivered to the grid (labeled “AC Out”) is excess AC power not being used by the AC loads. Selling requires an inverter/charger with **Grid Tied** mode available and active.

Input Modes

The FXR inverter has many modes of operation. See the *FXR Series Inverter/Charger Operator's Manual* for additional information on these modes, including reasons and considerations for using each mode.

The modes determine how the inverter interacts with an AC source. Each mode has functions and priorities that are intended for a designated application. Each of the inverter's input selections can be set to a different operating mode to support different applications.

- **Generator:** This mode is intended for a wide range of AC sources, including generators with a rough or imperfect AC waveform. The inverter can use generator power even when the generator is undersized or substandard.
- **Support:** This mode is intended for systems using the utility grid or a generator. AC source size, wiring, or other limitations may require temporary assistance to run very large loads. The inverter adds renewable or battery power to the AC source to ensure that the loads receive the power they require. This mode can reduce peak load demand from the utility.
- **Grid Tied:** This mode is intended for grid-interactive systems. When renewable energy sources charge the batteries above a selected "target" voltage, the inverter will send the excess energy to any loads. If the loads do not use all the excess energy, then the inverter will send (sell) that energy to the utility grid.
- **NOTE:** This mode is only available in 24-volt and 48-volt models.
- **UPS:** This mode is intended for systems primarily intended to maintain power to the loads with minimal interruption when switching between AC input and batteries. The response speed has been increased so that if an AC disconnect occurs the response time will be minimized.
- **Backup:** This mode is intended for systems that have the utility grid or a generator available, but do not have specialty requirements such as selling or support. The AC source will flow through the inverter to power the loads unless power is lost. If power is lost, then the inverter will supply energy to the loads from the battery bank until the AC source returns.
- **Mini Grid:** This mode is intended for systems that have the utility grid as an input and a sizable amount of renewable energy. The system will run off the renewable energy until the battery voltage falls to a specified low level. When this occurs, the inverter will connect to the utility grid to power the loads. The inverter will disconnect from the utility grid when the batteries are sufficiently recharged.
- **Grid Zero:** This mode is intended for systems that have the utility grid as an input and a sizable amount of renewable energy. The loads will remain connected to the utility grid, but will restrict the grid use except when no other power is available. The default power sources are the batteries and renewable energy, which attempt to "zero" the use of the AC source. The batteries are discharged and recharged (from renewable sources) while remaining grid-connected. This mode does not allow the inverter to charge batteries or sell.

Programming

Selection of the input modes and all other inverter programming are performed using a system display such as the MATE3. The system display can customize a wide range of parameters. 

Renewable Energy



The inverter cannot connect directly to PV, wind turbines, or other renewable sources. The batteries are the inverter's primary source of power. However, if the renewable sources are used to charge the batteries, the inverter can use their energy by drawing it from the batteries.

The renewable source is always treated as a battery charger, even if all of its power is used immediately. The renewable source must have a charge controller, or some other regulation method, to prevent overcharging. OutBack Power's FLEXmax family of charge controllers can be used for this purpose, as can other products.

Battery Bank

When planning a battery bank, consider the following:

- **Cables:** Recommendations for battery cable size and length are shown on page 20. The maximum length will determine the placement of the battery bank. Local codes or regulations may apply and may take priority over OutBack recommendations.
- **Battery Type:** The FXR inverter/charger uses a three-stage charge cycle.
 - ~ The cycle was designed for lead-chemistry batteries intended for deep discharge. These include batteries for marine, golf-cart, and forklift applications. They also include gel-cell batteries and absorbed glass-mat (AGM) batteries. OutBack Power recommends the use of batteries designed specifically for renewable energy applications. Automotive batteries are strongly discouraged and will have a short life if used in inverter applications.
 - ~ Using OutBack’s Advanced Battery Charging (ABC), most charging stages can be reconfigured or omitted from the cycle if necessary. The charger can be customized to charge a wide range of battery technologies including nickel, lithium-ion, and sodium-sulfur batteries. This programming is performed using the system display. 
- **Nominal Voltage:** These inverters are designed to work with specific battery bank voltages, which are different depending on inverter model. Before constructing a battery bank, check the inverter model and confirm nominal battery voltage.
- **Charger Settings and Maintenance:** A vented battery enclosure may be required by electric code and is usually recommended for safety reasons. It may be necessary to use a fan to ventilate the battery enclosure. Batteries must be regularly maintained according to the instructions of the battery manufacturer.

	<p>IMPORTANT:</p> <p>Battery charger settings need to be correct for a given battery type. Always follow battery manufacturer recommendations. Making incorrect settings, or leaving them at factory default settings, may cause the batteries to be undercharged or overcharged.</p>
	<p>CAUTION: Hazard to Equipment</p> <p>Batteries can emit vapors which are corrosive over long periods of time. Installing the inverter in the battery compartment may cause corrosion which is not covered by the product warranty. (Sealed batteries may be an exception.)</p>

- **Bank Size:** Battery bank capacity is measured in amp-hours. Determine the required bank specifications as accurately as possible, beginning with the items below. This avoids underperformance or wasted capacity. These ten items are obtainable in different places, summarized in Table 3 on the next page. Some of the information is specific to the site or application. Some can be obtained from the battery manufacturer. Information on OutBack products is available from OutBack Power Technologies or its dealers.

- A. Size of load:
 - B. Daily hours of use:
 - C. Days of autonomy:
- } These are the most basic and essential factors used to determine bank size.
- D. Application: This often helps define or prioritize the previous three items. Off-grid systems often require enough capacity to last for an extended period before recharging. Grid-connected systems frequently need only enough capacity for short-term backup during outages.
 - E. Conductor efficiency: Wire size and other factors will waste power due to resistance and voltage drop. Typical acceptable efficiency is 96 to 99%.
 - F. Inverter efficiency: FXR specifications list “Typical Efficiency” to help estimate operating loss.
- } Any losses are essentially amp-hour capacity that the system cannot use. The battery bank size can be increased to account for losses.

- G. System DC voltage: Each inverter model requires a specific DC voltage to operate.
- H. Battery voltage: Most individual battery voltages are less than the system DC voltage. The batteries may need to be placed in series to deliver the correct voltage.
- I. Capacity: Battery capacity, which is measured in amp-hours, is not usually a fixed number. It is specified based on the rate of discharge. For example, the OutBack EnergyCell 200RE is rated at 154.7 Ahr when discharged at the 5-hour rate (to terminal voltage 1.85 Vpc). This is a high rate of discharge that would hypothetically drain the battery in 5 hours. The same battery is rated at 215.8 Ahr when used at the 100-hour rate. Use the appropriate discharge rate (correlated to the expected loads) to measure the capacity of a battery. Use battery specifications for terminal voltage 1.85 Vpc whenever possible.

NOTE: Capacity ratings are for batteries at 25°C. Capacity is reduced at cooler temperatures.

- J. Maximum depth of discharge (DoD): Most batteries cannot be discharged below a certain level without damage. The bank requires enough total capacity to keep this from happening.

Table 3 Battery Bank Elements

Item	Source of information
A. Load Size	Site-specific
B. Daily Hours	Site-specific
C. Days of Autonomy	Site-specific
D. Application	Site-specific
E. Conductor Efficiency	Site-specific
F. Inverter Efficiency	Inverter manufacturer
G. System Vdc	Inverter manufacturer
H. Battery Vdc	Battery manufacturer
I. Capacity	Battery manufacturer
J. Maximum DoD	Battery manufacturer

To Calculate Minimum Battery Bank Size (refer to Table 3 for letter designations):

1. The load size, item A, is measured in watts. Compensate this figure for efficiency loss. Multiply the conductor efficiency by the inverter efficiency (E x F). (These items are represented as percentages, but may be displayed as decimals for calculation.) Divide item A by the result.
2. Convert the compensated load into amperes (Adc). Divide the step 1 result by the system voltage (item G).
3. Determine the daily load consumption in ampere-hours (amp-hours, or Ahr). Multiply the step 2 result by the daily usage hours (item B).
4. Adjust the total for required days of autonomy (the days the system must operate without recharging) and the maximum DoD. Multiply the step 3 result by C and divide by J.

The result is the total amp-hour capacity required for the battery bank.

5. Determine the number of parallel battery strings required. Divide the Ahr figure from step 4 by the individual battery capacity (I). Round the result to the next highest whole number.
6. Determine the total number of batteries required. Divide the system voltage by the battery voltage (G ÷ H). Multiply the result by the step 5 result.

The result is the total required quantity of the chosen battery model.

EXAMPLE #1

- | | |
|---|--|
| A. Backup loads: 1.0 kW (1000 W) | 1) $A \div [E \times F]$ $1000 \div (0.98 \times 0.93) = 1097.2 \text{ W}$ |
| B. Hours of use: 8 | 2) $1 \div G$ $1097.2 \div 48 = 22.9 \text{ Adc}$ |
| C. Days of autonomy: 1 | 3) $2 \times B$ $22.9 \times 8 = 182.9 \text{ Ahr}$ |
| D. Grid-interactive system (FXR3048A inverter) | 4) $[3 \times C] \div J$ $[182.9 \times 1] \div 0.8 = 228.6 \text{ Ahr}$ |
| E. Conductor efficiency: 98% (0.98) | 5) $4 \div I$ $228.6 \div 199.8 = 1.14$ (rounded to 2) |
| F. Inverter efficiency: 93% (0.93) | 6) $[G \div H] \times 5$ $[48 \div 12] \times 2$ strings = 8 batteries |
| G. System voltage: 48 Vdc | |
| H. Batteries: OutBack EnergyCell 220GH (12 Vdc) | |
| I. Capacity at 8-hour rate: 199.8 Ahr | |
| J. Maximum DoD: 80% (0.8) | |

EXAMPLE #2

A. Backup loads: 720 W	1) $A \div [E \times F]$	$720 \div (0.97 \times 0.9) = 801.8 \text{ W}$
B. Hours of use: 3	2) $1 \div G$	$824.7 \div 24 = 34.4 \text{ Adc}$
C. Days of autonomy: 2	3) $2 \times B$	$34.4 \times 3 = 103.1 \text{ Ahr}$
D. Off-grid system (VFXR3524A inverter)	4) $[3 \times C] \div J$	$[103.1 \times 2] \div 0.5 = 412.4 \text{ Ahr}$
E. Conductor efficiency: 97% (0.97)	5) $4 \div I$	$412.4 \div 167.5 = 2.5$ (rounded to 3)
F. Inverter efficiency: 92% (0.9)	6) $[G \div H] \times 5$	$[24 \div 12] \times 3$ strings = 6 batteries
G. System voltage: 24 Vdc		
H. Batteries: OutBack EnergyCell 200RE (12 Vdc)		
I. Capacity at 8-hour rate: 167.5 Ahr		
J. Maximum DoD: 50% (0.5)		

Generator

- FXR inverters can accept power from a single-phase generator that delivers clean AC power in the range of voltage and frequency specified for that model.
 - ~ Inverters stacked for split-phase output (120/240 Vac) can work with both output lines of a split-phase generator.
 - ~ Inverters stacked for three-phase output can work with three-phase generators.
- The inverter/charger can provide a start signal to control an automatic start generator. If automatic generator starting is required, the generator must be an electric-start model with automatic choke. It should have two-wire start capability. For other configurations, additional equipment may be required.
- In any configuration, the inverter may need to be specifically programmed using the system display.  Perform all programming according to the specifications of the generator and the required operation of the inverter. Parameters to be programmed may include generator size, automatic starting requirements, and potential fluctuations in generator AC voltage.
- A generator that is to be installed in a building usually should **not** have a bond between the neutral and ground connections. The generator should only be bonded if there is a specific need. Installations in North America are expected to bond the neutral and ground at the main electrical panel. See page 18 for more information on neutral-ground bonding.

Generator Sizing

A generator should be sized to provide enough power for all the loads and the battery charger. The generator size should assume maximum loads and maximum charging at the same time.

- Available generator power may be limited by ratings for circuit breakers and/or generator connectors.
- The generator must be able to provide current to all inverters on a given phase or output. Minimum generator size² is usually recommended to be twice the power of the inverter system. For example, a 2 kVA inverter should have a 4 kVA generator. Many generators may not be able to maintain AC voltage or frequency for long periods of time if they are loaded more than 80% of rated capacity.
- In addition, if a split-phase 120/240 Vac generator is powering a single-phase 120 Vac inverter system with no other compensation, it is **required** to be at least twice the power of the inverters. A split-phase generator that is heavily loaded on one output line may suffer severely from balancing issues. The OutBack FW-X240 or PSX-240 balancing transformers may compensate for this condition.

² This is the generator size after derating for environment, use, and other factors.



Installation

Location and Environmental Requirements

Sealed (FXR) models are resistant to water and other elements but are not designed for permanent outdoor installations. If outdoor installation is required, the FXR inverter must be installed under cover and protected from direct exposure to the environment. Vented (VFXR) models are not resistant to water and other elements. They must be installed indoors.

- The inverter can often be mounted in any position or orientation. If there is any exposure to moisture or condensation, the inverter must not be mounted upside-down. This ensures that water will not accumulate under the DC cover. However, it can still be mounted in other positions or orientations.
- For installations where the inverter may be exposed to water spray, a sealed model must be used and mounted either with the base down (shelf mounting) or with the AC wiring compartment facing down (wall mounting). If mounted with the base down, water cannot be allowed to accumulate around the inverter's base. There is a drainage system on the base of the inverter to dispel condensation. If submerged, water can enter this drain and cause failure.
- Vented inverters must be installed in a weather-proof enclosure or enclosed area. These models are not designed for exposure to water or excessive wind-blown dust and debris.
- When inverters are installed with an OutBack FLEXpower system, the system must be installed in the upright orientation due to the requirements of the circuit breakers.
- Any inverter will perform more efficiently in locations offering plenty of air circulation. The recommended minimum clearance is 2 inches (5 cm) on all sides of the inverter.
- Any inverter will function to all of its specifications if operated in a range of -4°F to 122°F (-20°C to 50°C).
- The inverter will function, but will not necessarily meet its specifications, if operated in a temperature range of -40°F to 140°F (-40°C to 60°C). This is also the allowable temperature range for storage.
- The FXR series of inverters carry an Ingress Protection (IP) rating of 20 and a Relative Humidity (RH) rating of 93% (non-condensing).
- Inverter specifications are listed in the *FXR Series Inverter/Charger Operator's Manual*.

Tools Required

- Wire cutters/strippers
- Torque wrenches
- Assorted insulated screwdrivers
- DVM or standard voltmeter

Mounting

- One person can install the FXR inverter, but installation may be easier with two people.
- The unit has four mounting holes, one in each corner. Use fasteners in all corners for a secure installation.



IMPORTANT:

Use correct fasteners to secure the inverter to the mounting surface, regardless of the type of surface. OutBack cannot be responsible for damage to the product if it is attached with inadequate fasteners.

- Due to the variance in other mounting methods, OutBack only endorses the use of FLEXware mounting products or previous versions of OutBack mounting plates. Use M6 x 20 mm machine screws, one per corner, to attach the inverter to the mounting plate. Follow the instructions with each mounting system.
- Mount and secure each component before attaching any wiring.
- When the inverter is used with other metal chassis, make sure that all chassis are grounded appropriately. (See the grounding instructions on page 18.) Grounding other chassis may involve metal-to-metal contact, or separate ground wires.

If using an OutBack FLEXware Mounting Plate, avoid large air gaps behind the plate. These can result in louder mechanical noise during heavy inverting or charging. Mount the plate on a flat, solid mounting surface.

Dimensions

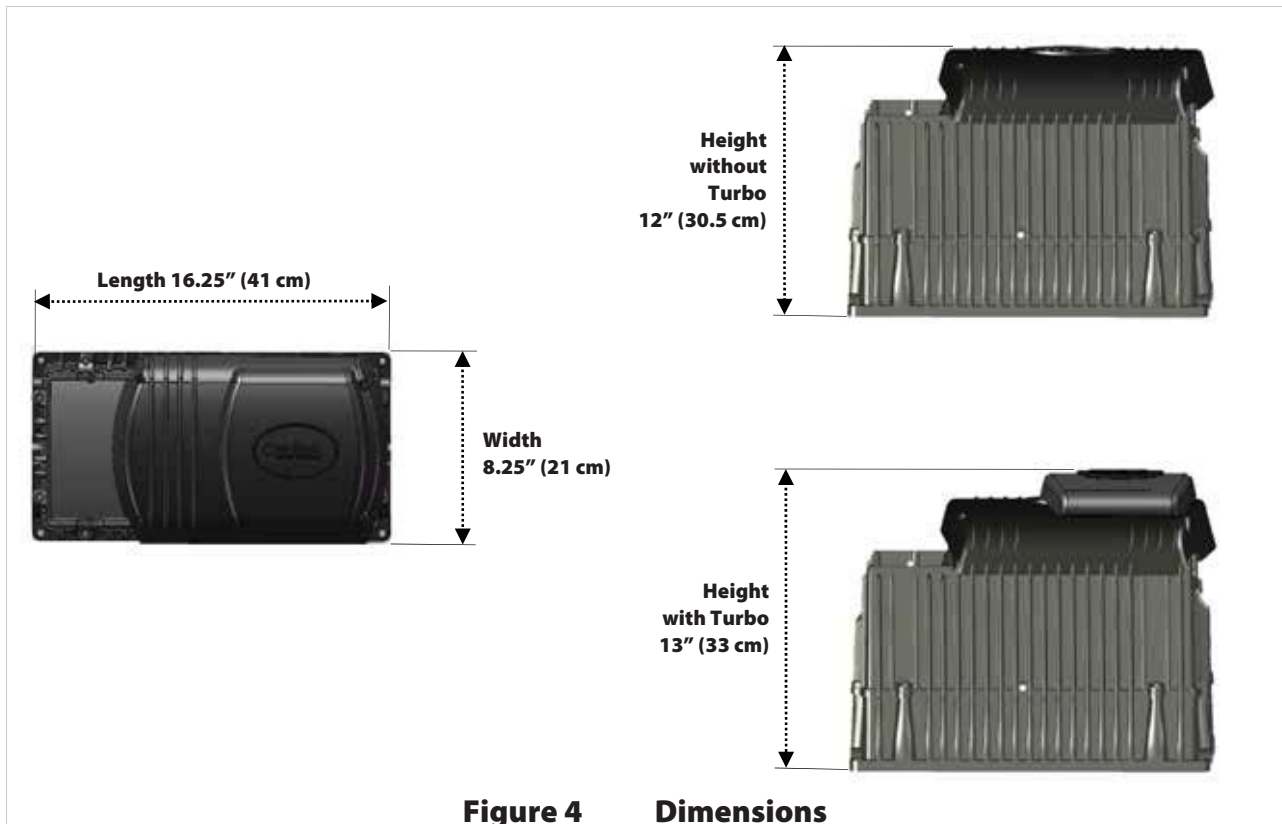

Terminals and Ports

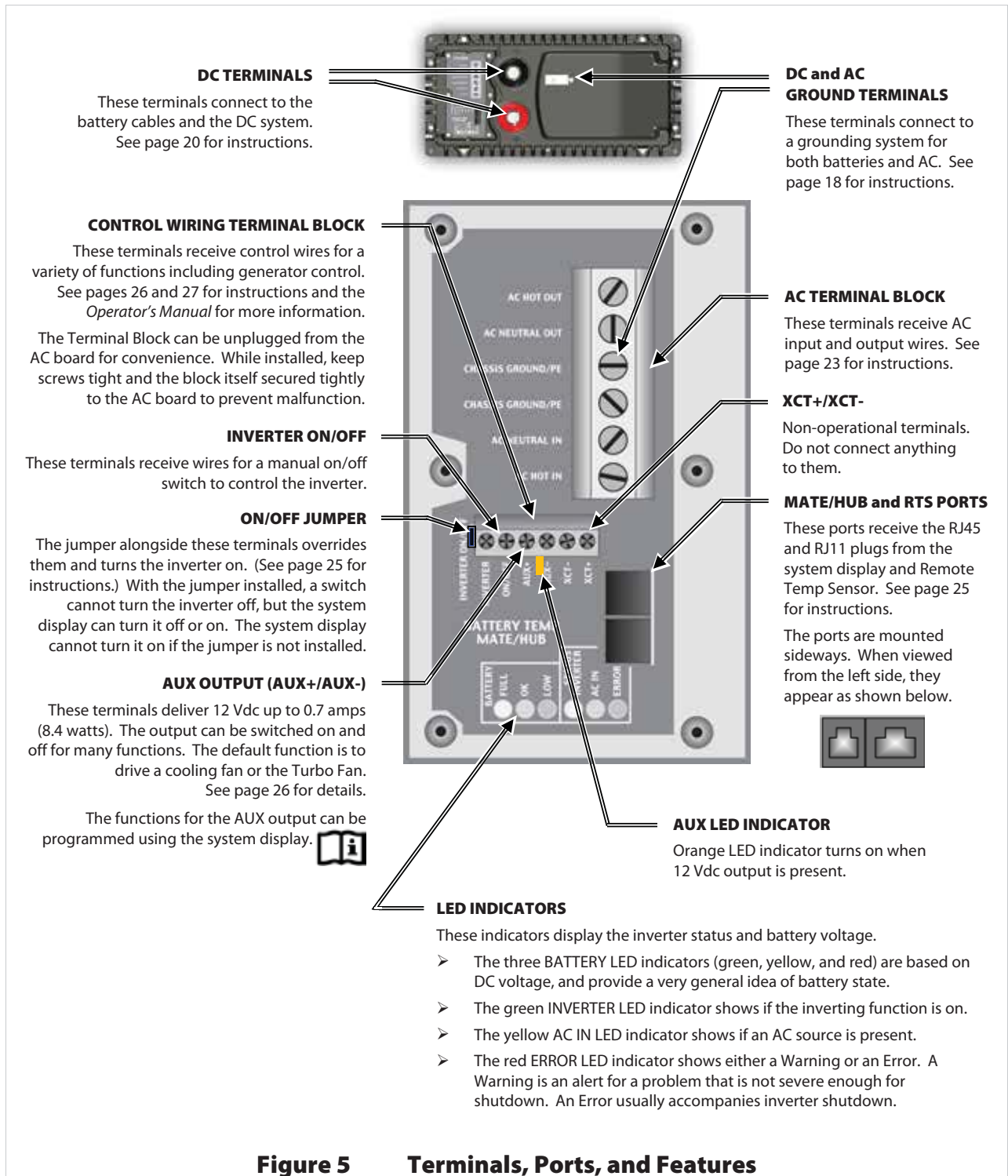

Figure 5 Terminals, Ports, and Features

NOTE: The INVERTER ON/OFF Jumper is installed to the ON position during manufacture, but the FXR inverter is given an external OFF command at the same time. Its initial state is OFF.

Wiring

It will be necessary to remove knockouts from the AC Plate to run wires. The AC Plate has one knockout of ½" size and two knockouts of ¾" size. Install appropriate bushings to protect the wires.

Use copper wire only. Wire must be rated at 75°C or higher.

Grounding



	<p>WARNING: Shock Hazard</p> <ul style="list-style-type: none"> ➤ This unit meets the IEC requirements of Protection Class I. ➤ The unit must be connected to a permanent wiring system that is grounded according to the IEC 60364 TN standard. ➤ The input and output circuits are isolated from ground. The installer is responsible for system grounding according to all applicable codes. ➤ For safety, the neutral and ground conductors should be mechanically bonded. OutBack does not bond these conductors within the inverter. Some codes require the bond to be made at the main panel only. Make sure that no more than one bond is present in the AC system at any time.
	<p>WARNING: Shock Hazard</p> <p>For all installations, the negative battery conductor should be bonded to the grounding system at only one point. If the OutBack GFDI is present, it can provide the bond.</p>
	<p>IMPORTANT:</p> <p>Not all OutBack products can be used in a positive-ground system. If it is necessary to build a positive-ground system with OutBack products, contact OutBack Technical Support at +1.360.618.4363 before proceeding. Additionally, consult the online forum at www.outbackpower.com/forum/, where this subject has been discussed extensively.</p>

Table 4 Ground Conductor Size and Torque Requirements

Terminal Location	Minimum Conductor Size	Torque Requirements
Central AC Terminals	#10 AWG (0.009 in ²) or 6 mm ²	25 in-lb (2.8 Nm)
DC Box Lug	#6 AWG (0.025 in ²) or 16 mm ²	45 in-lb (5.1 Nm)

Table 4 contains OutBack’s recommendations for minimum safe cable sizes. Other codes may supersede OutBack’s recommendations. Consult applicable codes for final size requirements.

The inverter's DC ground is a box lug located next to the negative DC battery terminal. This lug accepts up to 1/0 AWG (70 mm² or 0.109 in²) wire. Local codes or regulations may require the DC ground to be run separately from the AC ground. Also, if present, it will be necessary to remove the DC Cover or Turbo Fan before making the ground connection. (See page 22.)

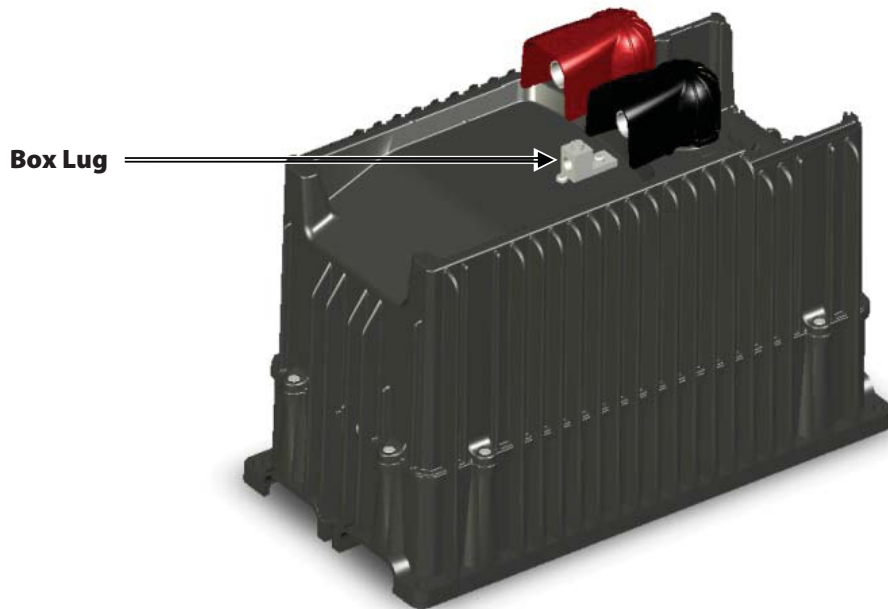
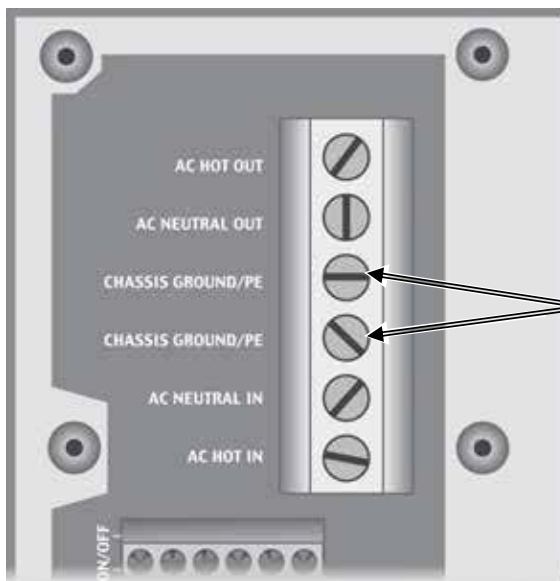

Figure 6 DC Ground Lug



CHASSIS GROUND/PE

The two CHASSIS GROUND/PE terminals are electrically common. If connecting to an external ground bus, only one terminal needs to be used. The other terminal may be used if connecting to a device with its own ground wire, such as a generator.

Figure 7 Chassis Ground/PE

DC Wiring





	<p>WARNING: Shock Hazard</p> <p>Use caution when working in the vicinity of the inverter's battery terminals.</p>
	<p>CAUTION: Equipment Damage</p> <p>Never reverse the polarity of the battery cables. Always ensure correct polarity.</p>
	<p>CAUTION: Fire Hazard</p> <ul style="list-style-type: none"> ➤ The installer is responsible for providing overcurrent protection. Install a circuit breaker or overcurrent device on each DC positive (+) conductor to protect the DC system. ➤ Never install extra washers or hardware between the mounting surface and the battery cable lug. The decreased surface area can build up heat. See the hardware diagram on page 21.
	<p>IMPORTANT:</p> <ul style="list-style-type: none"> ➤ The DC terminals must be encased in an enclosure to meet the requirements of some local or national codes. ➤ Table 5 contains OutBack's recommendations for minimum safe cable sizes. Other codes may supersede OutBack's recommendations. Consult applicable codes for final size requirements.

Table 5 DC Conductor Size and Torque Requirements

Inverter (Wattage/Voltage)	Nominal DC Amps (Derated 125%)	Conductor Size ³ (Minimum)	Breaker Size (Minimum)
FXR2012A	200	4/0 AWG (120 mm ²) or 0.186 in ²	250 Adc
VFXR2812A	280	4/0 AWG (120 mm ²) or 0.186 in ²	250 Adc
FXR2524A	125	2/0 AWG (70 mm ²) or 0.109 in ²	175 Adc
VFXR3524A	175	4/0 AWG (120 mm ²) or 0.186 in ²	250 Adc
FXR3048A	75	1/0 AWG (70 mm ²) or 0.109 in ²	125 Adc
VFXR3648A	90	1/0 AWG (70 mm ²) or 0.109 in ²	125 Adc
Terminal Location		Torque Requirements	
Inverter DC Terminals		60 in-lb (6.9 Nm)	
Battery Terminals		See battery manufacturer's recommendations	

When installing DC cables:

- Battery positive and negative cables DC should be no longer than 10 feet (3 meters) each, to minimize voltage loss and other possible effects.
- Turn off DC circuit breakers or remove fuses before proceeding.
- Tie, tape, or twist cables together to reduce self-inductance. Run positive and negative cables through the same knockouts and conduit.
- The inverter's battery terminal is a threaded stud which accepts a ring terminal lug. Use crimped and sealed copper ring lugs with 5/16 inch (0.79 cm) holes, or use compression lugs.
- Install all overcurrent devices on the positive cable.

³ Cable sizes are for each inverter in a system. In a system with multiple inverters, each inverter requires its own cables and overcurrent devices of the size indicated.

To install DC cables and hardware:

1. Install all DC cables.

Do not install hardware in a different order from Figure 8. The battery cable lug should be the first item installed on the stud. It should make solid contact with the mounting surface.

Do not close the main DC disconnect until wiring is complete and the system is prepared for commissioning.

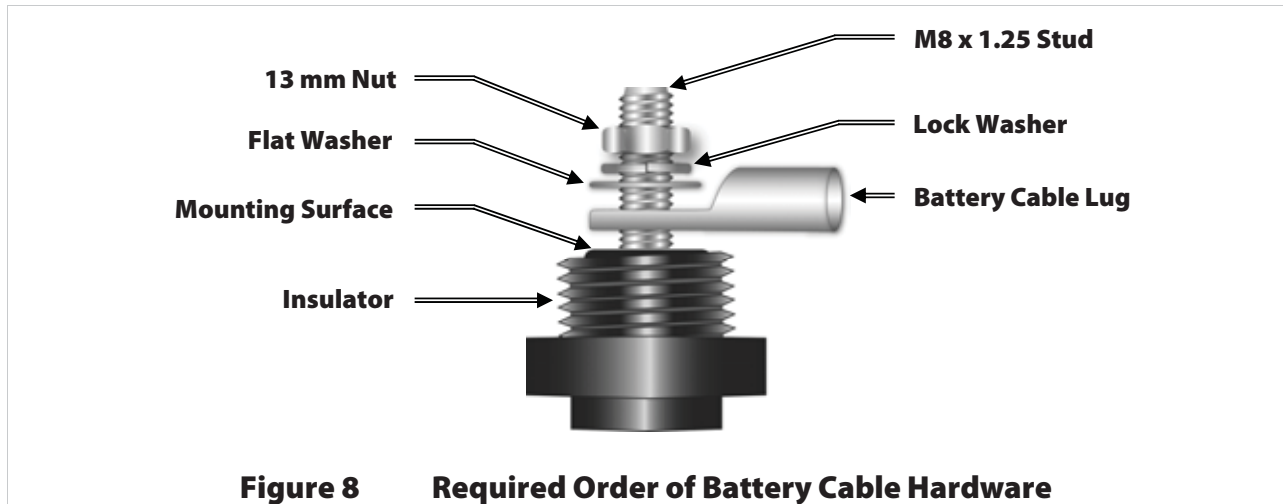

CAUTION: Fire Hazard

Never install extra washers or hardware between the mounting surface and the battery cable lug. The decreased surface area can build up heat.

2. Install the battery terminal covers. These are made of stiff plastic with a snap-on design.

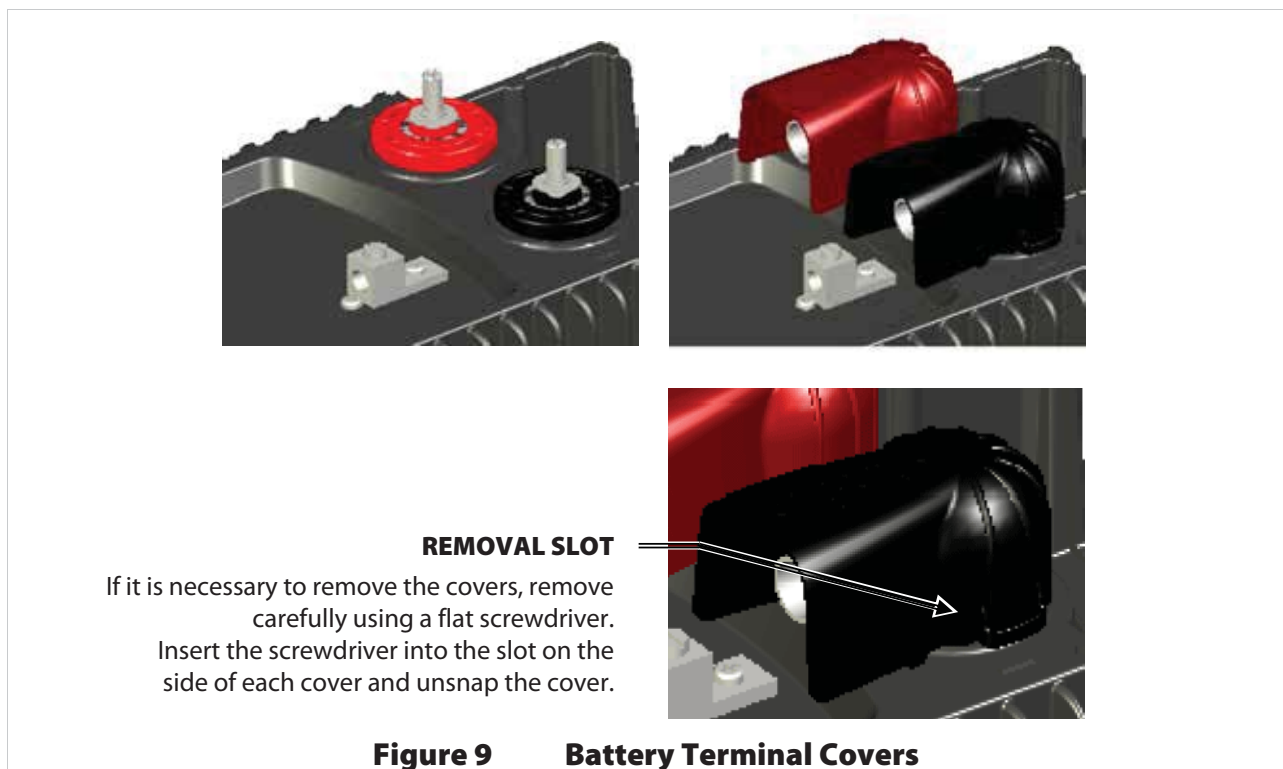



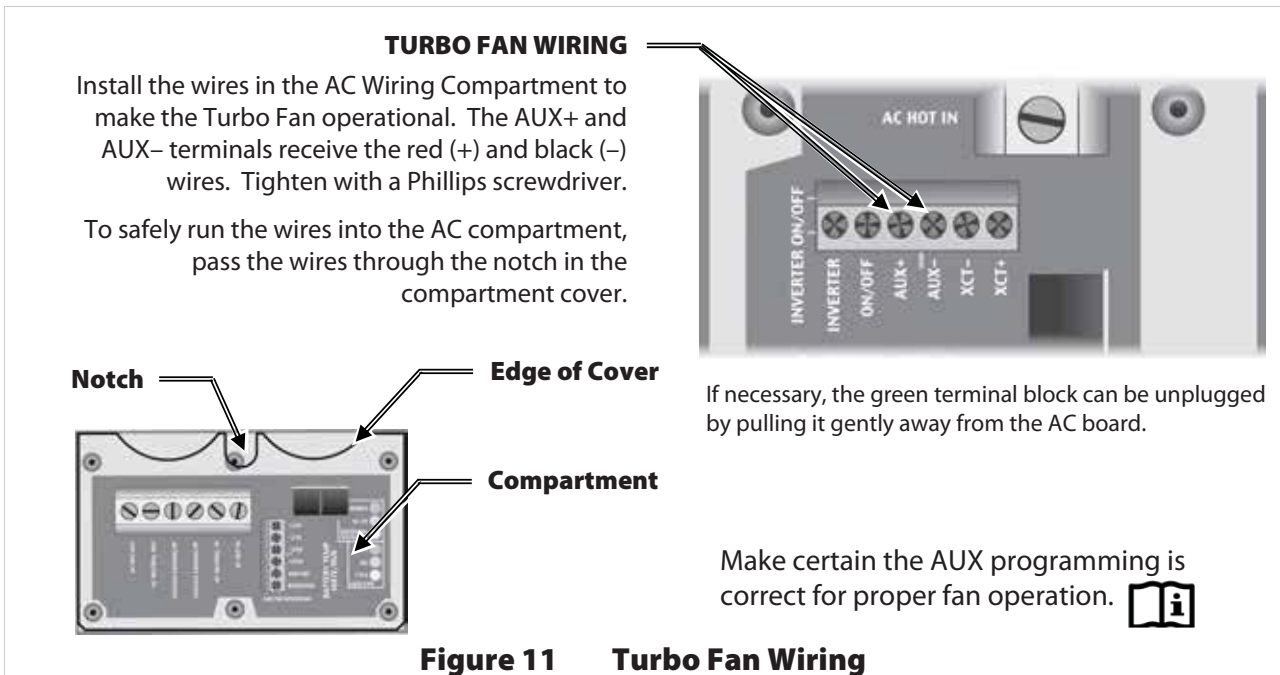

DC Cover or Turbo Fan Attachment



If it is necessary to remove the Turbo Fan:

1. Remove the compartment cover.
2. Unscrew the AUX+ and AUX- terminal screws.
3. Remove the wires.
4. Remove the screws at the four corners of the Turbo Fan.
5. Remove the Turbo Fan.

AC Wiring

	<p>WARNING: Shock Hazard</p> <ul style="list-style-type: none"> ➤ The neutral and ground conductors should be mechanically bonded. Ensure there is no more than one AC neutral-ground bond at any time. ➤ Local or national codes may require the bond to be made at the main panel only.
	<p>IMPORTANT:</p> <p>The AC input and output may need to be protected with branch-rated circuit breakers of maximum 60 Aac size to meet applicable code requirements.</p>
	<p>IMPORTANT:</p> <p>Applicable codes may prevent grid-interactive inverters from using an input circuit breaker larger than 40 amps. Confirm local requirements before installation.</p>
	<p>IMPORTANT:</p> <p>This page contains OutBack's recommendations for minimum safe cable sizes. Other codes may supersede OutBack's recommendations. Consult applicable codes for final size requirements.</p>

All system wiring must comply with national and local codes and regulations.

The FXR inverter's AC terminal block has six positions for AC wires. The minimum recommended size is #6 AWG (16 mm²) or 0.021 in² wire. This is also the largest size that the terminal will accept.

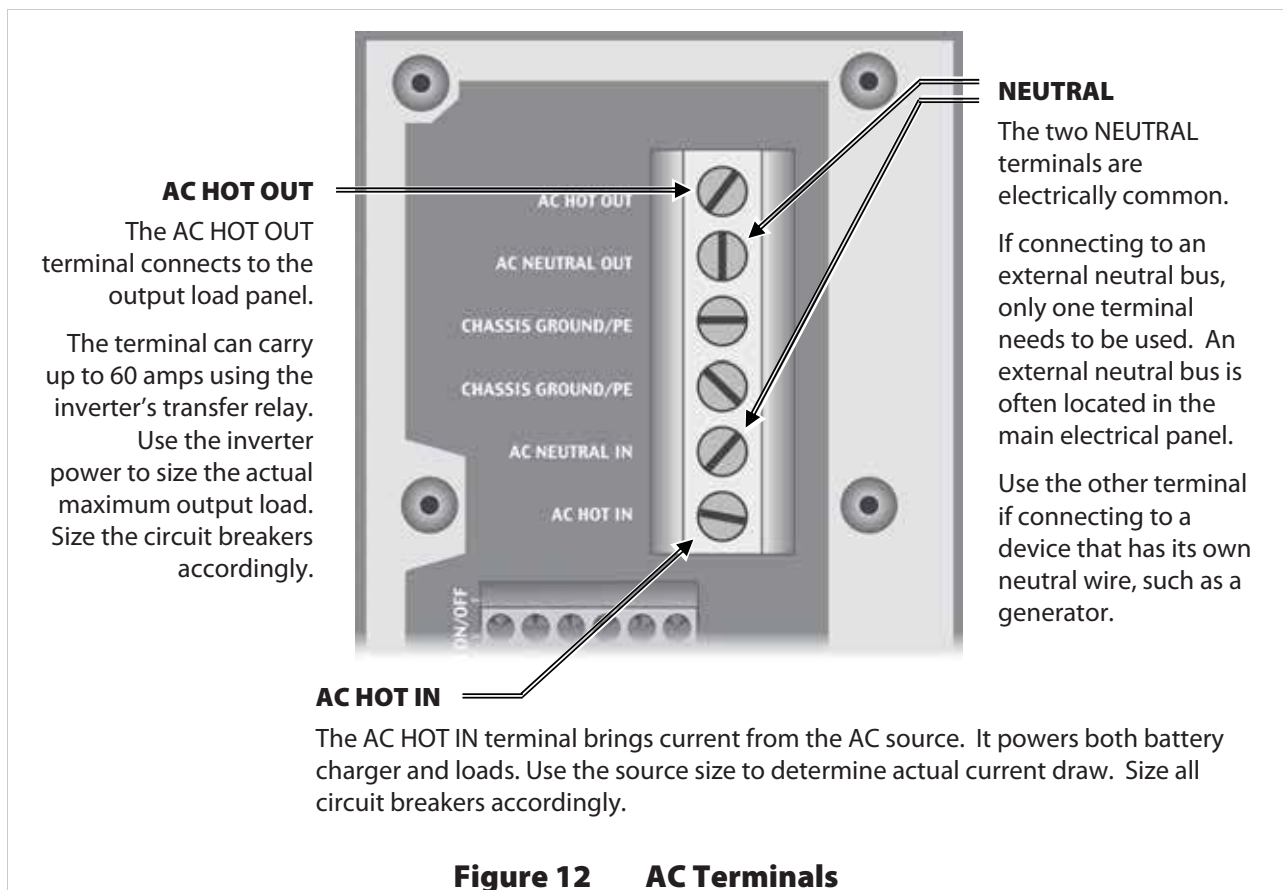

Figure 12 AC Terminals

AC Sources

The inverter has a single set of AC terminals which are intended to connect to a single AC source. **It cannot be directly wired to more than one AC source at the same time.** If multiple sources are used, it is usually required to have a selector switch that changes from one to the next. The switch should be the “break before make” type which disconnects from one source before contacting another. This prevents the risk of connecting to two out-of-phase sources at the same time or connecting them to each other.

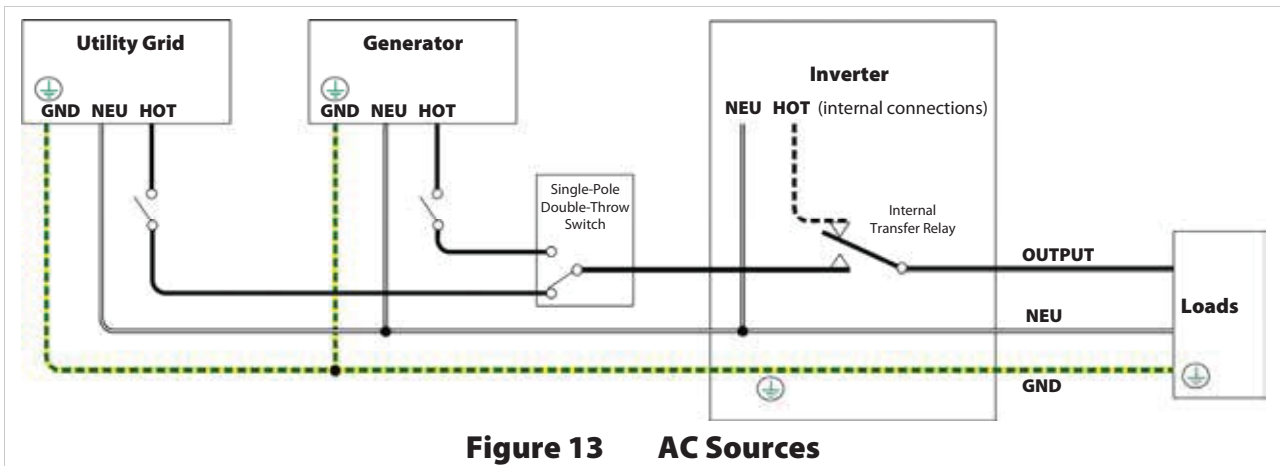

Figure 13 AC Sources

The inverter’s transfer relay is normally set to provide inverter power to the output. This is shown in Figure 13, where the internal transfer relay is switched to the inverter function.

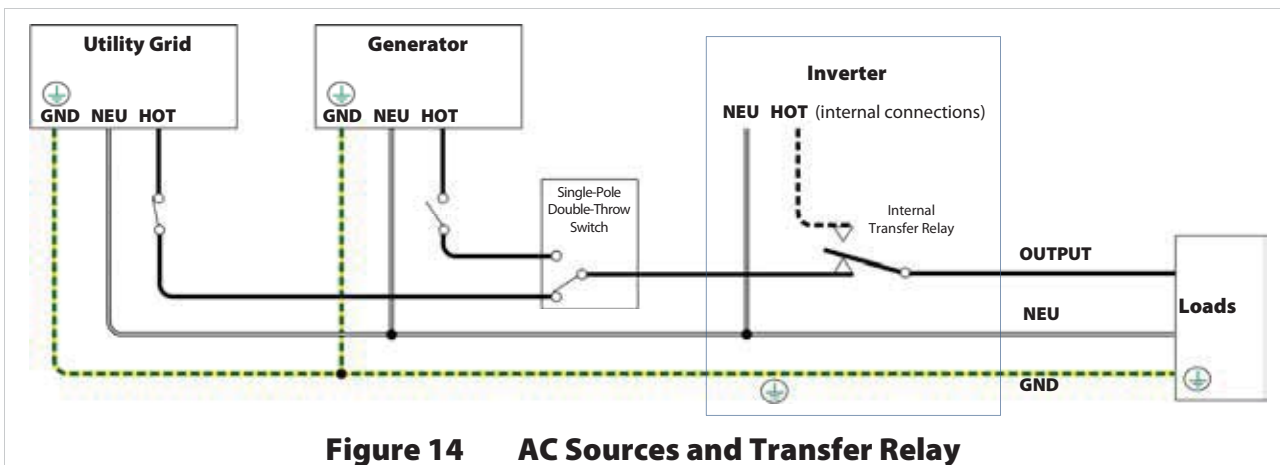

Figure 14 AC Sources and Transfer Relay

When an AC source is connected and accepted, the internal transfer relay switches to transfer the AC source power to the loads. Figure 14 shows the utility grid switch closed. The internal transfer relay has switched accordingly so that the loads receive utility power. (See the *Operator’s Manual* for the inverter’s acceptance criteria.)

ON and OFF Wiring

The INVERTER ON/OFF jumper bridges two pins. The ON/OFF jumper parallels the two INVERTER ON/OFF terminals on the Control Wiring Terminal Block. If either connection is closed, the inverter is ON. The jumper is installed in the factory, but the inverter is given an external OFF command at the same time. Its initial state will be OFF. (An inverter in the OFF state will not invert. However, it may still transfer power to loads and charge batteries from an AC source.)



Jumper Off

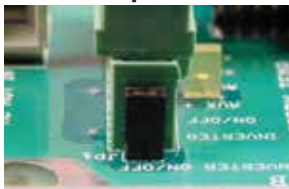

Jumper On

To turn the inverter initially ON, remove the jumper briefly and then replace it. This requires long-nose pliers or a similar tool.

After this, removing the jumper will immediately turn the inverter OFF.



Once the jumper has been removed, the INVERTER ON/OFF terminals on the Control Wiring Terminal Block can be used to wire a manual on/off switch. These terminals can also be used to control an Emergency Power Off (EPO) device instead of a standard switch.

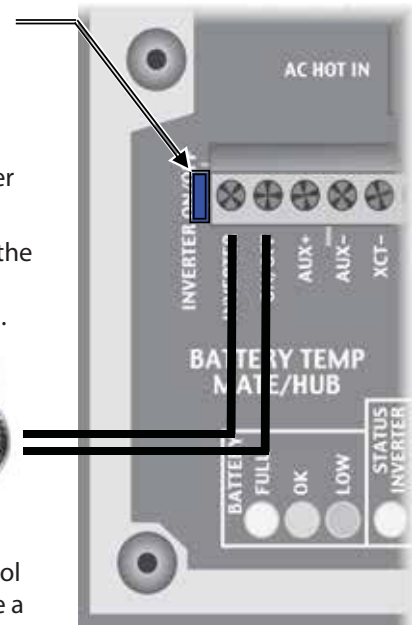

Figure 15 ON/OFF Jumper and Connections

Accessory Wiring

The AC Wiring Compartment Board has ports for both the Remote Temperature Sensor (RTS) and the system display. The system display port is labeled MATE/HUB. If a HUB Communications Manager is in use, it occupies the inverter's MATE/HUB port.

RTS cable
RJ11,
4-conductor,
telephone)



MATE cable
RJ45, 8-conductor,
CAT5 non-crossover

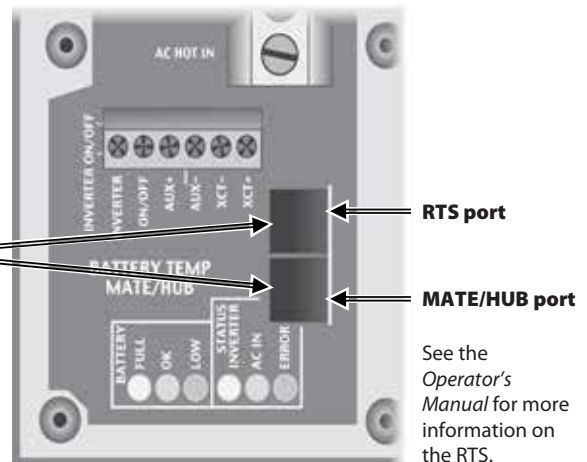

See the *Operator's Manual* for more information on the RTS.

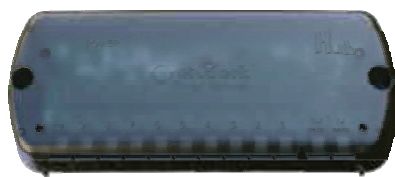

Additional ports

MATE port

When a HUB product occupies the inverter's MATE/HUB port, the system display connects directly to the HUB product. Inverters plug into ports 1 and above. Charge controllers and other devices plug into unassigned ports not used by inverters. See Stacking on page 30 for information on connecting inverters. See the HUB product literature for other devices.

Figure 16 Accessory Connections

AUX Wiring

The **AUX+** and **AUX-** terminals are a switched 12 Vdc supply. The **AUX** can respond to different criteria and control many functions. These include cooling fans, vent fans, load diversion, fault alarms, and the **Advanced Generator Start** (AGS) function.

The terminals can supply up to 0.7 amps at 12 Vdc (8.4 watts). This is sufficient to drive a small fan or a relay controlling a larger device. The terminals accept wire up to #14 AWG (2.5 mm²). The **AUX** circuit contains electronic overcurrent protection, which resets after being overloaded. No additional fuses are required for the **AUX** terminals.

The default setting for the **AUX** output is to control the Turbo Fan included with sealed models. (See Figure 17.) The **AUX** output can only control one function at a time. It cannot be used for anything else if the Turbo Fan is connected.

The control logic for the **AUX** output is not always located in the same device. Inverter **AUX** functions are located within the inverter itself and are described accordingly. Although inverter-based functions require the system display for programming, they will function even if the display is removed. However, AGS programming is located within the system display and will not work if the display is removed. Other devices may also be able to control the terminals. For generator control, see page 27.

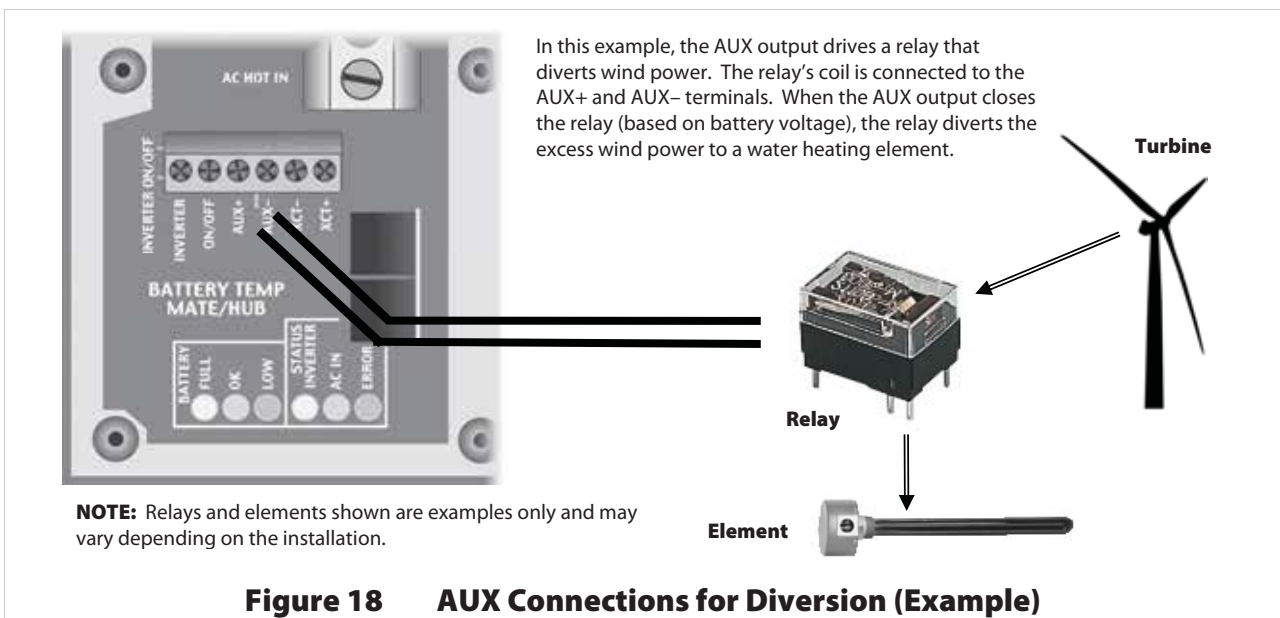
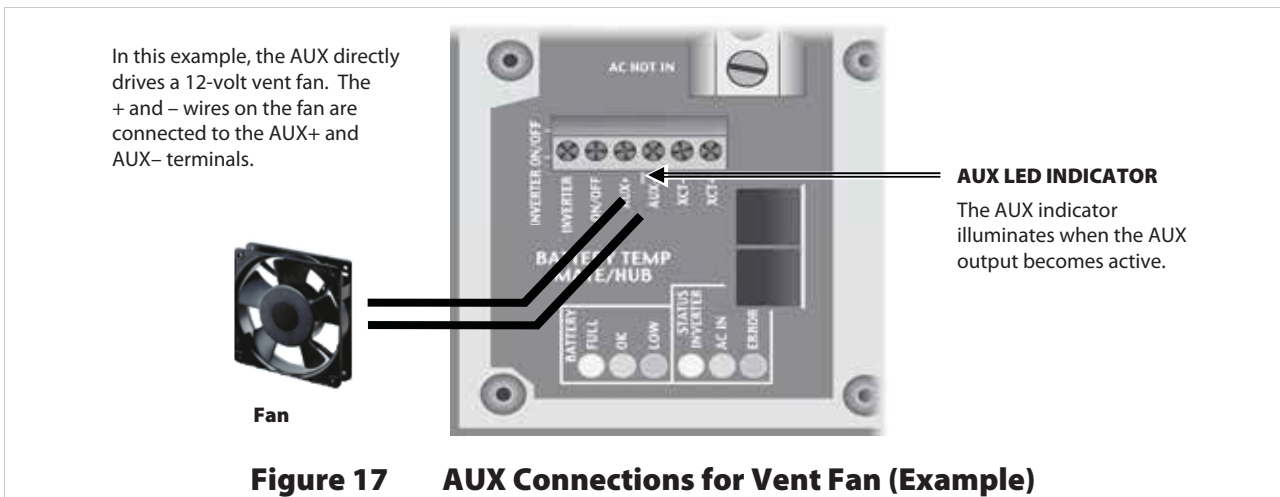

Generator Control

The AUX terminals can provide a signal to control an automatic-start generator. The control function can be **Advanced Generator Start** (AGS), which is situated in the system display. AGS can start the generator using settings from the system display, or it can use battery readings from the FLEXnet DC battery monitor. Alternately, the control function can be **Gen Alert**, which is a simpler function based directly in the FXR inverter. The choice of control function depends on system needs and the capabilities of each device.

The generator must be an electric-start model with automatic choke. It is recommended to have “two-wire” start capability. A two-wire-start generator is the simplest type, where the cranking and starting routine is automated. It usually has a single switch with two positions that is turned ON to start, OFF to stop.

Two-Wire-Start

The 12 Vdc signal provided by the **AUX** output can be switched on and off to provide a start signal. It is possible to send a 12-Vdc signal directly to the generator. However, this should never be done if it connects the **AUX** output directly to the generator’s own battery. It is more common to use the **AUX** terminals to energize the coil of a 12 Vdc automotive or similar relay.

The OutBack FLEXware Relay Assembly depicted in Figure 19 is sold for this purpose. The relay contacts can serve in place of the generator’s start switch. The battery shown below is depicted for clarity. In most cases, it is part of the generator’s internal starting circuit and is not an external component.

The drawing below is one example of a possible arrangement. Specific arrangements, relays, and other elements depend on the requirements of the installation and of the generator.

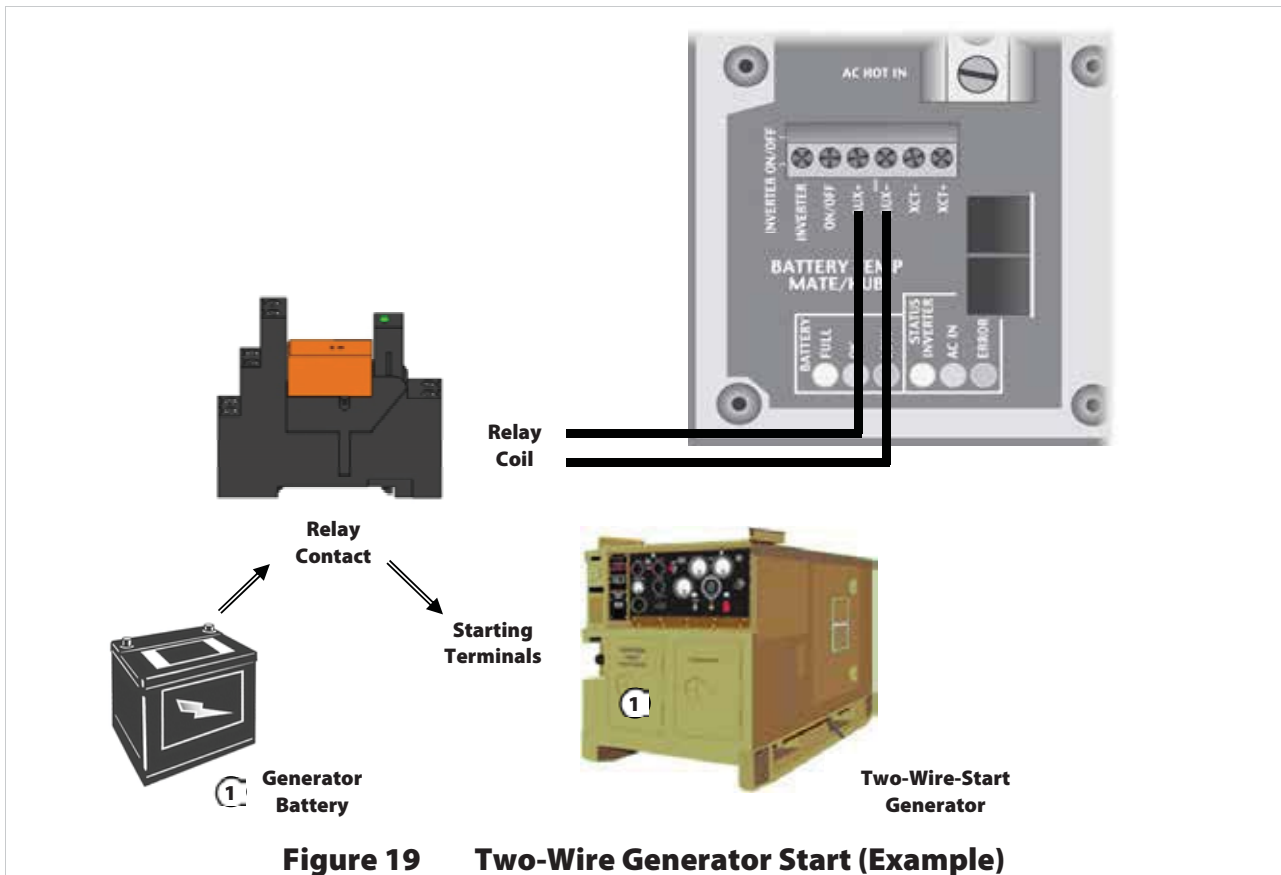

Installation

Three-Wire-Start

A “three-wire-start” generator has two or more starting circuits. It usually has a separate switch or position for cranking the generator. A three-wire generator has fewer automated functions than a two-wire. It usually requires multiple controls for starting, running, or stopping. The AUX terminals cannot control this type of generator without using a three-wire to two-wire conversion kit.

Atkinson Electronics (<http://atkinsonelectronics.com>) is one company that makes these kits. The Atkinson GSCM-Mini is intended to work with OutBack inverters.

The drawing below is one example of a possible arrangement. Specific arrangements, relays, and other elements depend on the requirements of the installation and of the generator.

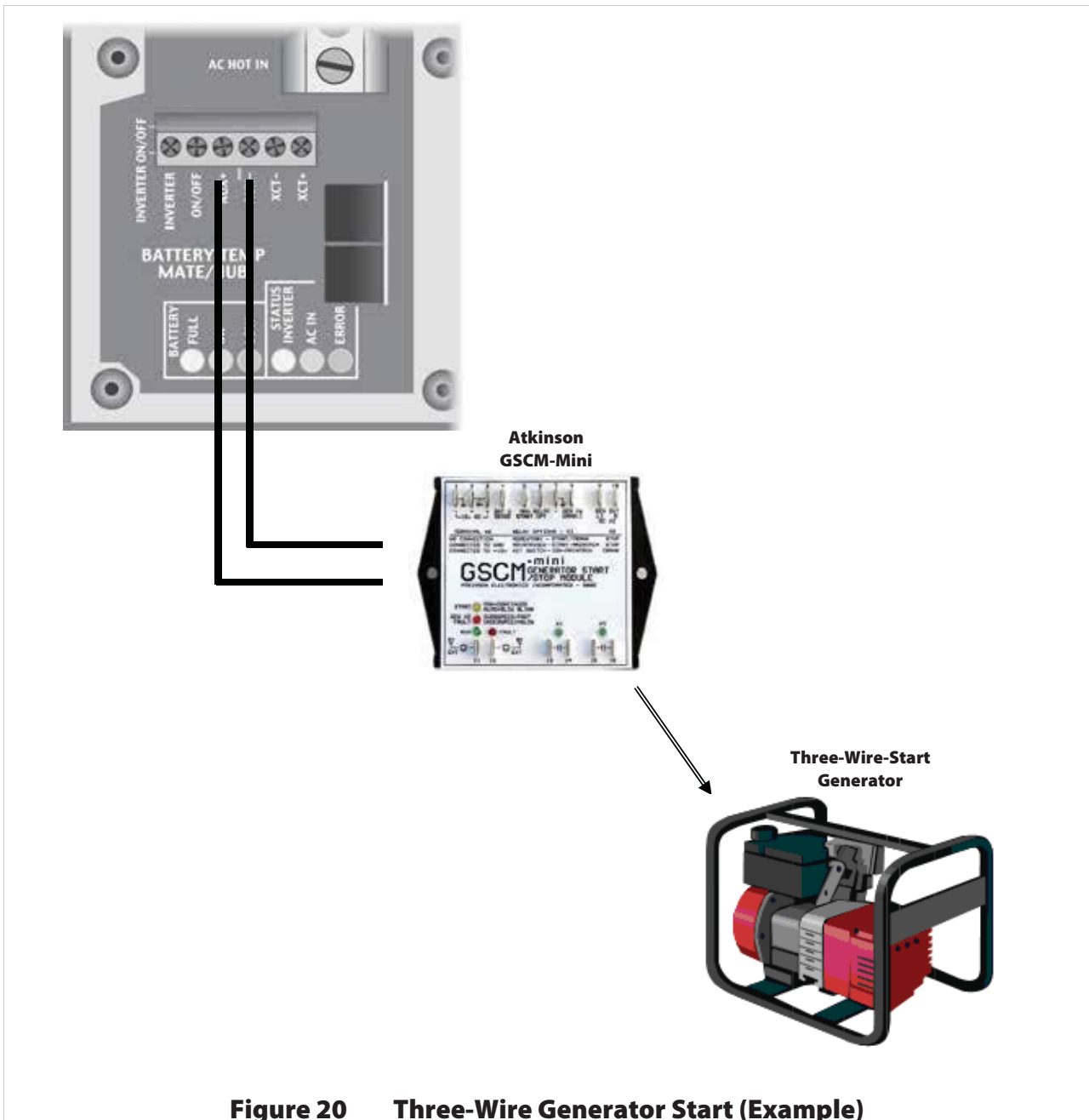

Figure 20 Three-Wire Generator Start (Example)

AC Configurations

Single-Inverter

When installing an inverter AC system, the following rules must be observed.

- All overcurrent devices must be sized for 60 Aac or less.
- All wiring must be sized for 60 Aac or more.
- All output circuit breakers must be sized appropriately for loads and inverter power.
- The AC input (generator or utility grid) must be a single-phase source of the proper voltage and frequency.

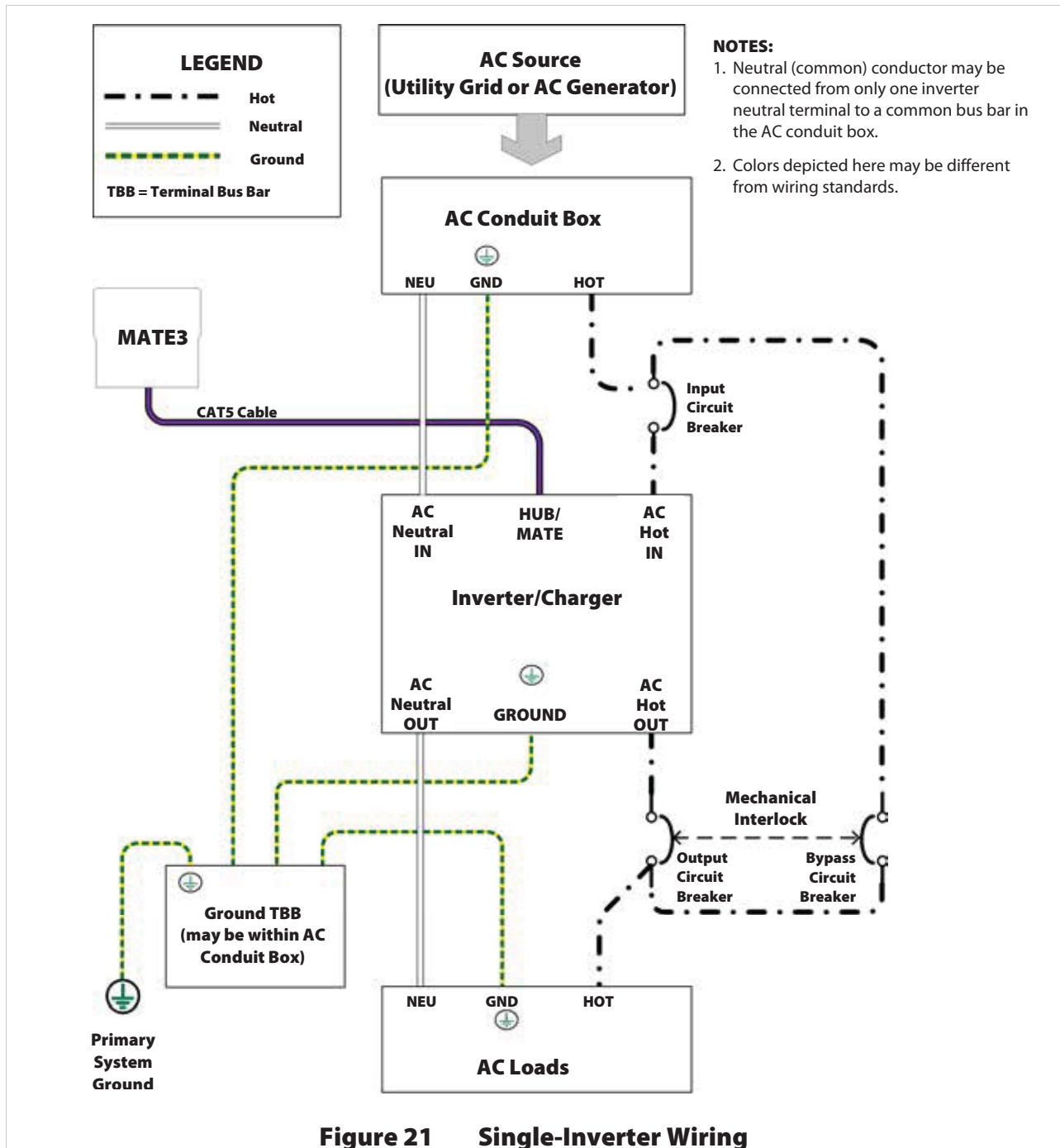

Multiple-Inverter AC Installations (Stacking)

Installing multiple inverters in a single AC system allows larger loads than a single inverter can handle. This requires stacking. Stacking inverters refers to how they are wired within the system and then programmed to coordinate activity. Stacking allows all units to work together as a single system. Examples of stacking configurations include “series”, “parallel”, “series/parallel”, and “three-phase”.

Stacking Connections

Stacking requires an OutBack HUB10.3 communications manager and a system display. Make all interconnections between the products with CAT5 non-crossover cable.

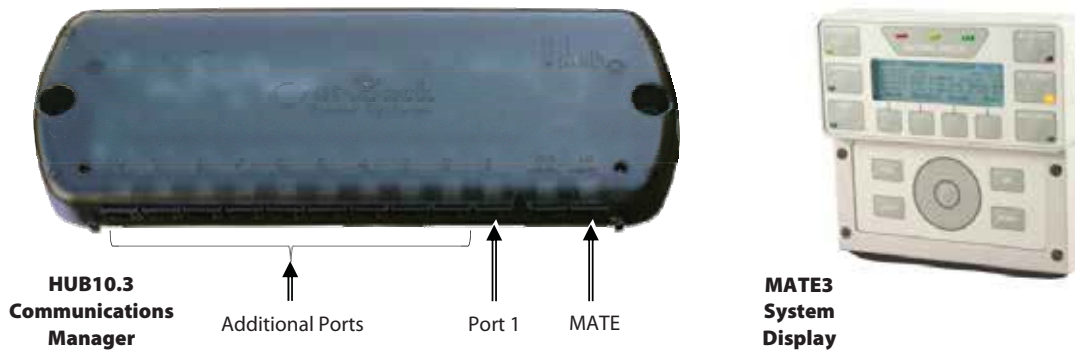

Each inverter must be assigned a stacking mode, “master” or “slave”, depending on the configuration.

- The master provides the primary output phase. Other inverters in the system base their phase on that of the master. If the master shuts off, all other inverters also shut off. The master must sense and connect to an AC source before other inverters can connect.

In a parallel-stacked system, the master tends to be the most heavily used unit.

“Subphase master” inverters are used in series or three-phase systems. A subphase master inverter operates semi-independently of the master inverter. Although the master inverter sets the phase relationship, the subphase master creates an output independent of the master.

The master on the L1 (or A phase) output cannot measure loads and voltages on any other output. The subphase masters for the other outputs perform monitoring and regulation for the phase they control.

- ~ In a series or series/parallel-stacked system, a subphase master is required for the L2 output.
- ~ In a three-phase system, subphase masters are required for both the B and C phases.
- A slave inverter does not create an independent output. It simply assists the master or subphase master by adding power to the output as needed.
 - ~ The Power Save function can place slave inverters in “Silent” mode when not in use. They are activated by the master or subphase master when required.

NOTE: The FW-X240 and similar transformers are not used for load balancing of stacked FXR inverters.

Each inverter is assigned to a particular phase when assigned a port on the HUB10.3 communications manager. Port assignments will vary with the system. The master must be plugged into port 1. In parallel stacking, any slave inverter can use any other port, beginning with port 2. In series or three-phase stacking, the port assignments are very specific. See the HUB10.3 literature for more information. Regardless, it is important to keep track of units and ports for programming purposes.

Programming uses the system display to assign a status and stacking value to the inverter on each port. As long as the master is plugged into port 1, these assignments can be changed as needed.



IMPORTANT:

- The master inverter must always be connected to port 1 on the communications manager. Connecting it elsewhere, or connecting a slave to port 1, will result in backfeed or output voltage errors which will shut the system down immediately.
- Installing multiple inverters without stacking them (or stacking them incorrectly) will result in similar errors and shutdown.
- Although stacking allows greater capacity, the loads, wiring, and overcurrent devices must still be sized appropriately. Overloading may cause circuit breakers to open or the inverters to shut down.

Stacking Configurations

Series Stacking (Dual-Stack)

In series stacking, two inverters create two separate 120 Vac⁴ output phases. One phase is the master. The second inverter is a subphase master. It creates a 120 Vac output that is intentionally 180° out of phase with the master. Each of these outputs can be used to power a separate set of 120 Vac loads. Collectively they form a “split-phase” configuration. This configuration produces 240 Vac, which can be used to power 240 Vac loads when both inverters work together.

- The two outputs operate independently of each other. The 120 Vac loads on each output cannot exceed a given inverter’s size. The second inverter cannot assist.
- Only two inverters, one per output, may be installed in a series arrangement. They must be the same model.

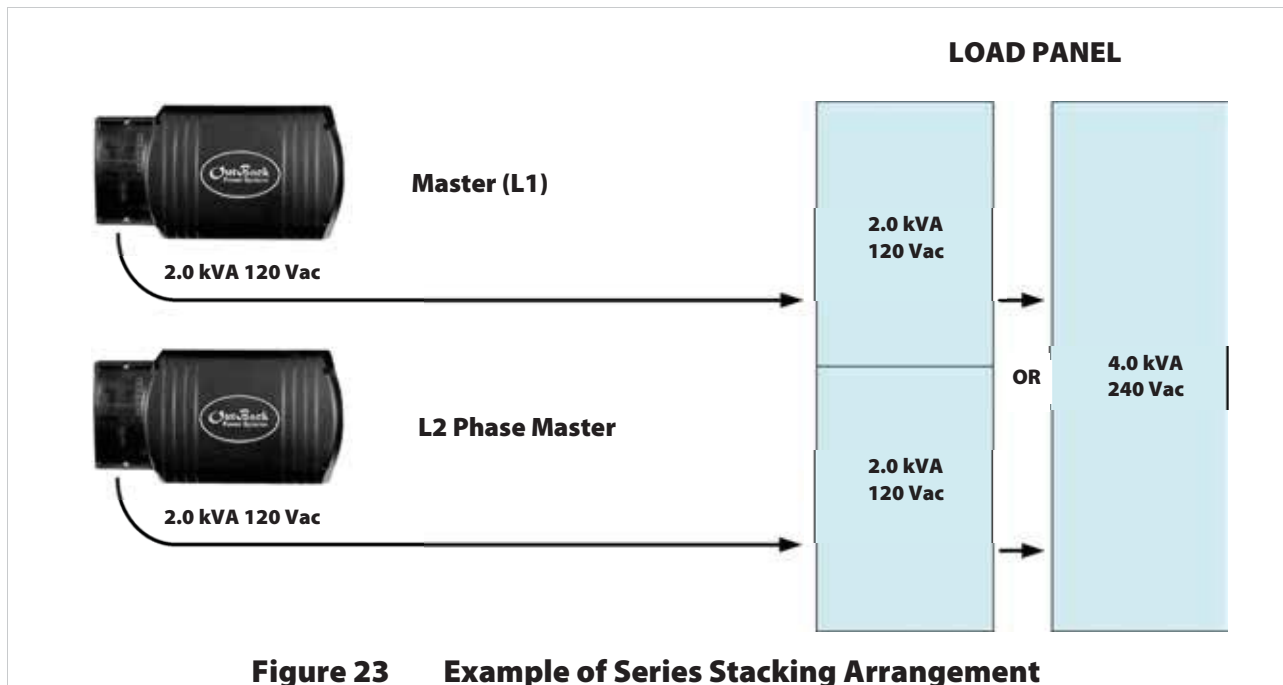

When installing a series inverter system, observe the following rules.

- Series stacking requires both the system display and the communications manager. See the HUB10.3 literature for any required jumper configurations.
- The master must be connected to communications manager port 1. It is programmed as **Master**. Other inverters must not be selected as master.

⁴ Output voltages may vary with regional voltage standards.
900-0166-01-00 Rev B

Installation

- The second inverter must be programmed as **L2 Phase Master**. It must be connected to port 7.
- All overcurrent devices must be sized for 60 Aac or less. All wiring must be sized for 60 Aac or more.
- All output circuit breakers must be sized appropriately for loads and inverter power.
- The AC input (generator or utility grid) must be a split-phase source of the proper voltage and frequency.
- When wiring the AC source to the inverters, local codes may require the inverter circuit breakers to be located at the bottom of the main panel. This prevents overloading of the AC bus.

NOTE: The FW-X240 and similar transformers are not used for load balancing of stacked FXR inverters.

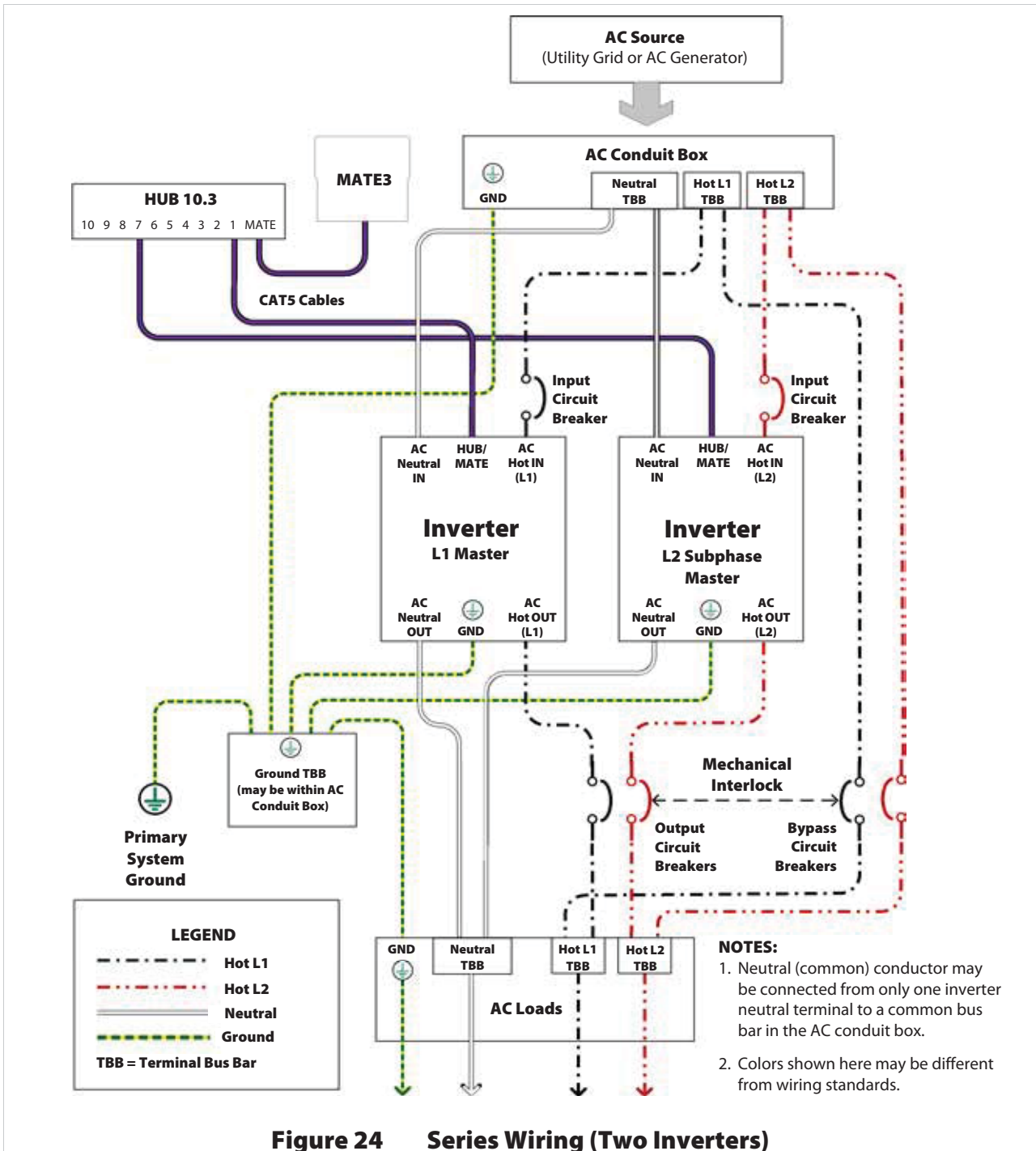
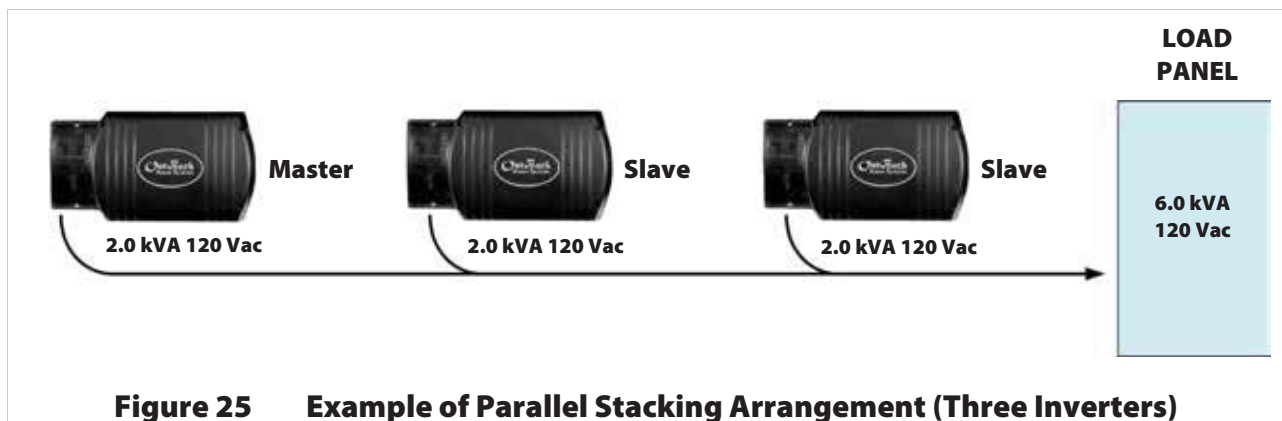

Figure 24 Series Wiring (Two Inverters)

Parallel Stacking (Dual-Stack and Larger)

In parallel stacking, two or more inverters create a single, common 120 Vac⁵ bus.

- The slave outputs are controlled directly by the master and cannot operate independently.
- All inverters share a common input (AC source) and run loads on a common output.
- Slave inverters can go into Silent mode when not in use. The master will activate individual slaves based on load demand. This reduces idle power consumption and improves system efficiency.
- Up to ten inverters may be installed in a parallel arrangement. The example on this page shows three inverters. The wiring diagram on the next page shows four. All inverters must be the same model.



When installing a parallel inverter system, observe the following rules.

- Parallel stacking requires both the system display and the communications manager. See the HUB10.3 literature for any required jumper configurations.
- The inverter that is mounted physically lowest is always the master and is programmed as **Master**.  Mounting below the other inverters allows the master to avoid heat buildup and remain relatively cool as it sees the greatest duty cycle.
- The master must be connected to port 1 of the communications manager. Other inverters must not be selected as master.
- All slave inverters, regardless of number, should be selected as **Slave** during programming. Slaves can be connected to any port numbered 2 and above.
- All overcurrent devices must be sized for 60 Aac or less. All wiring must be sized for 60 Aac or more.
- All output circuit breakers must be sized appropriately for loads and inverter power.
- The AC input (generator or utility grid) must be a single-phase source of the proper voltage and frequency.
- When wiring the AC source to the inverters, local codes may require the inverter circuits to be located at the opposite end of the panel from the main circuit breaker. This prevents overloading of the AC bus.

⁵ Output voltages may vary with regional voltage standards.
900-0166-01-00 Rev B

Installation

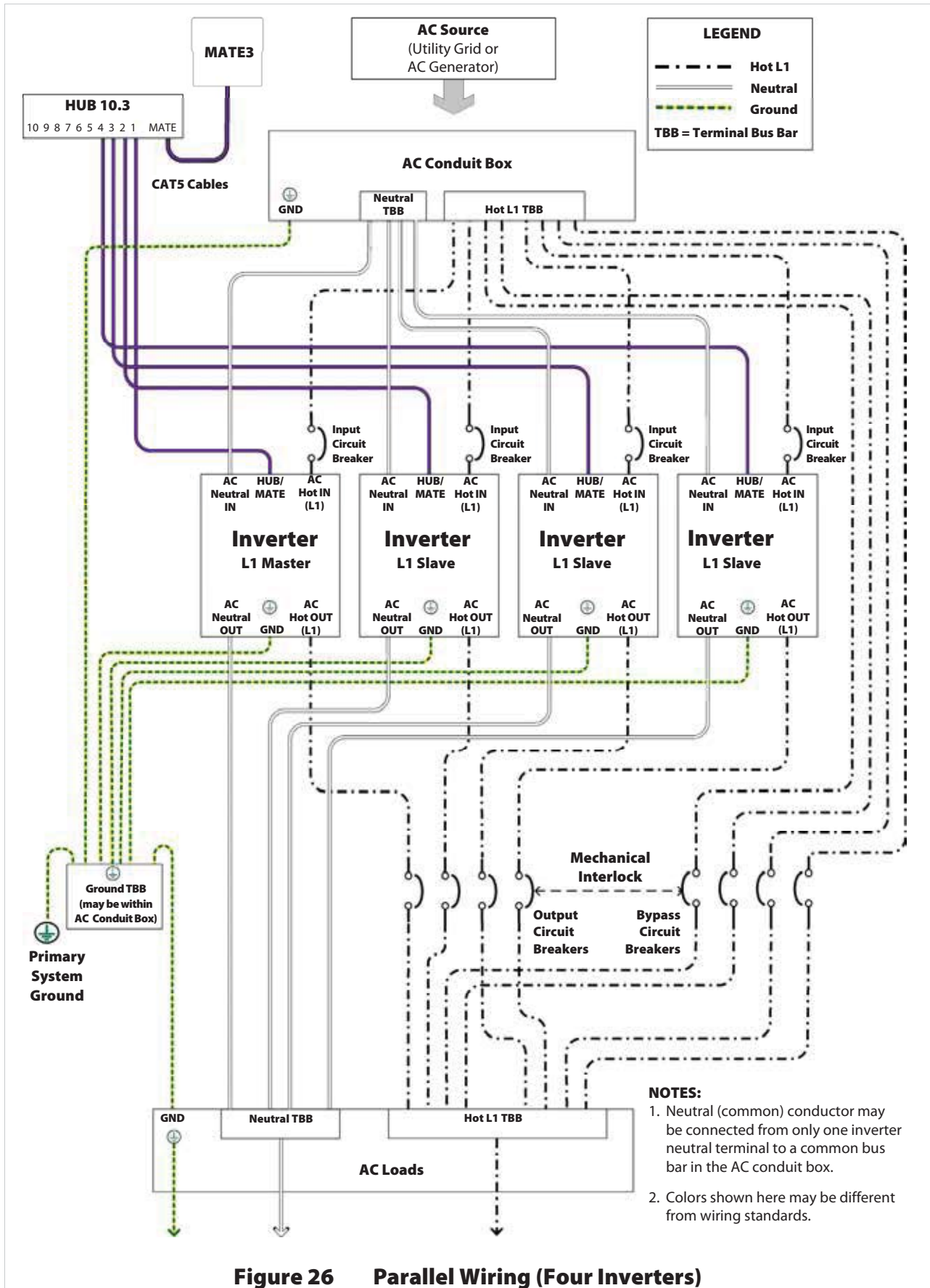
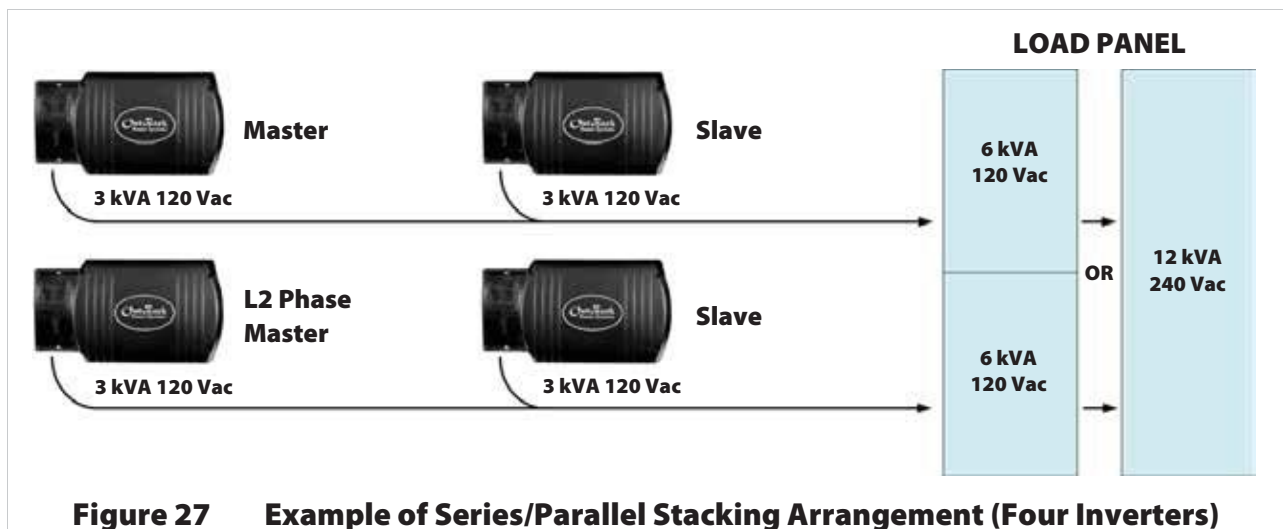

Figure 26 Parallel Wiring (Four Inverters)

Series/Parallel Stacking (Quad-Stack or Larger)

In series/parallel stacking, inverters create separate 120 Vac⁶ output phases and 240 Vac collectively, as in series stacking. However, in this configuration, each output has parallel inverters. One output contains the master; the other uses a subphase master. Each output has at least one slave.

- The 120 Vac loads on each output can exceed the size of a single inverter. They can be powered by all the inverters on that output.
- The slave outputs are controlled directly by their respective master inverters. They cannot operate independently. The slaves can go into Power Save mode when not in use.
- Up to eight inverters may be installed in a series/parallel arrangement. All inverters must be the same model.



When installing a multiple-inverter series/parallel system, observe the following rules.

- Series/parallel stacking requires both the system display and the communications manager. See the HUB10.3 literature for any required jumper configurations.
- The inverter that is mounted physically lowest is always master and is programmed as **Master**.  Mounting below the other inverters allows the master to avoid heat buildup and remain relatively cool as it sees the greatest duty cycle.
- The master must be connected to port 1 of the communications manager. Other inverters must not be selected as master.
- Any other inverter on the L1 output (parallel with the master) should be selected as **Slave** during programming. These can be connected to ports 2 through 4. L1 inverters cannot use other ports.
- The subphase master for the L2 output must be programmed as **L2 Phase Master**. It must be connected to port 7.
- Any other inverter on the L2 output (parallel with the subphase master) should be selected as **Slave** during programming. These can be connected to ports 8 through 10. L2 inverters cannot use other ports.
- All overcurrent devices must be sized for 60 Aac or less. All wiring must be sized for 60 Aac or more.
- All output circuit breakers must be sized appropriately for loads and inverter power.
- The AC input (generator or utility grid) must be a split-phase source of the proper voltage and frequency.
- When wiring the AC source to the inverters, local codes may require the inverter circuits to be located at the opposite end of the panel from the main circuit breaker. This prevents overloading of the AC bus.

NOTE: The FW-X240 and similar transformers are not used for load balancing of stacked FXR inverters.

⁶ Output voltages may vary with regional voltage standards.

Installation

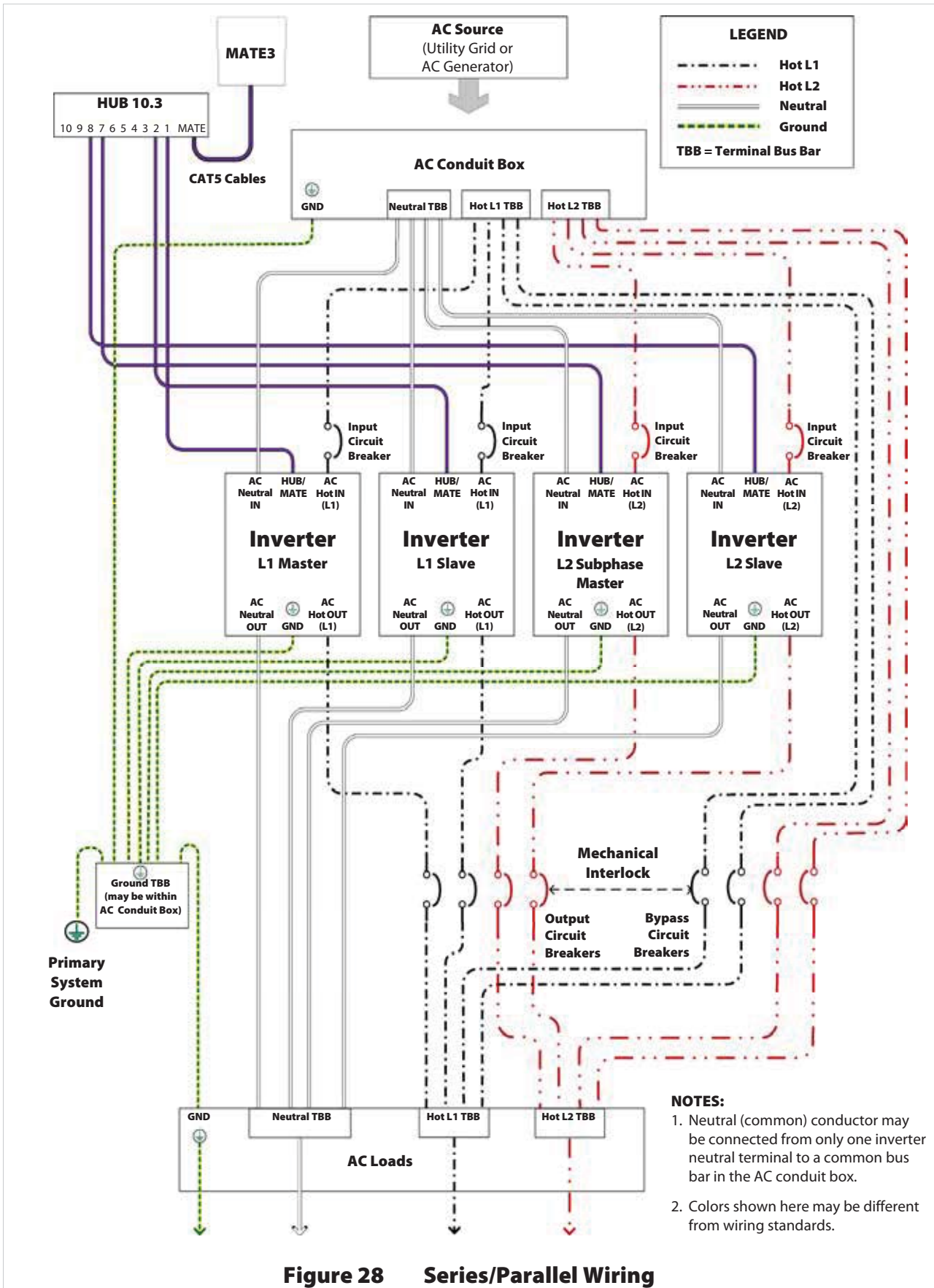
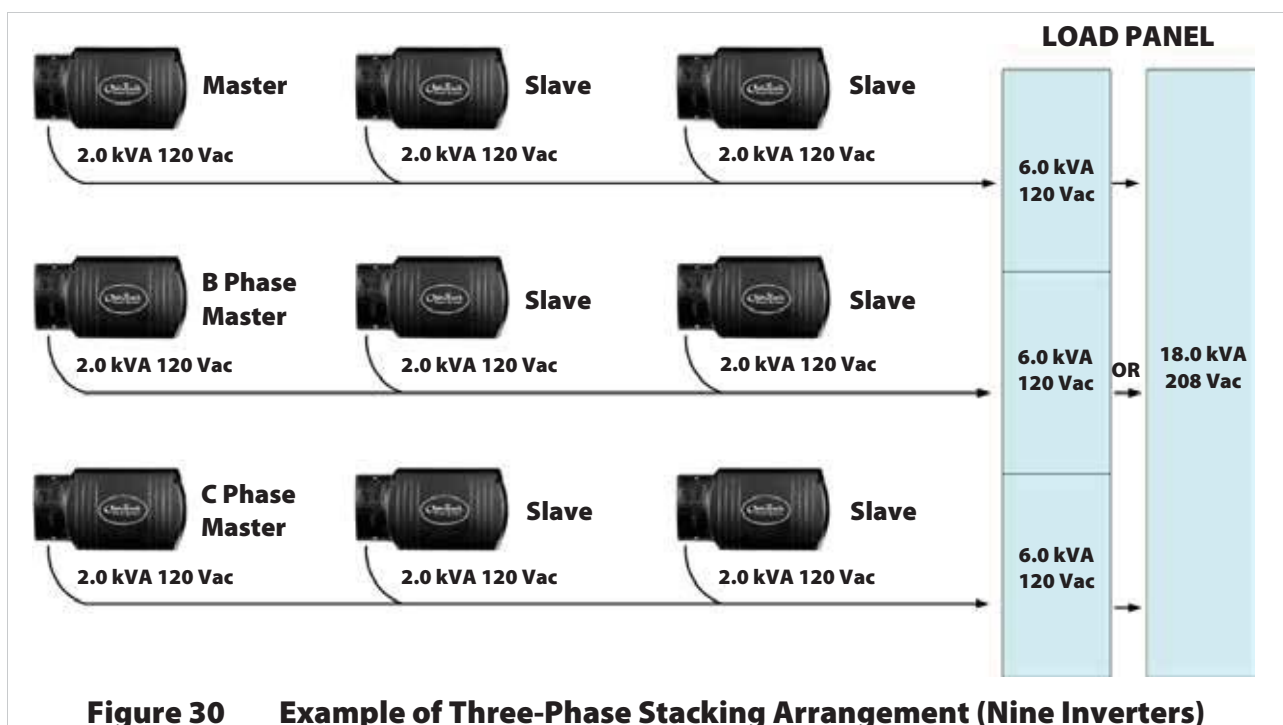
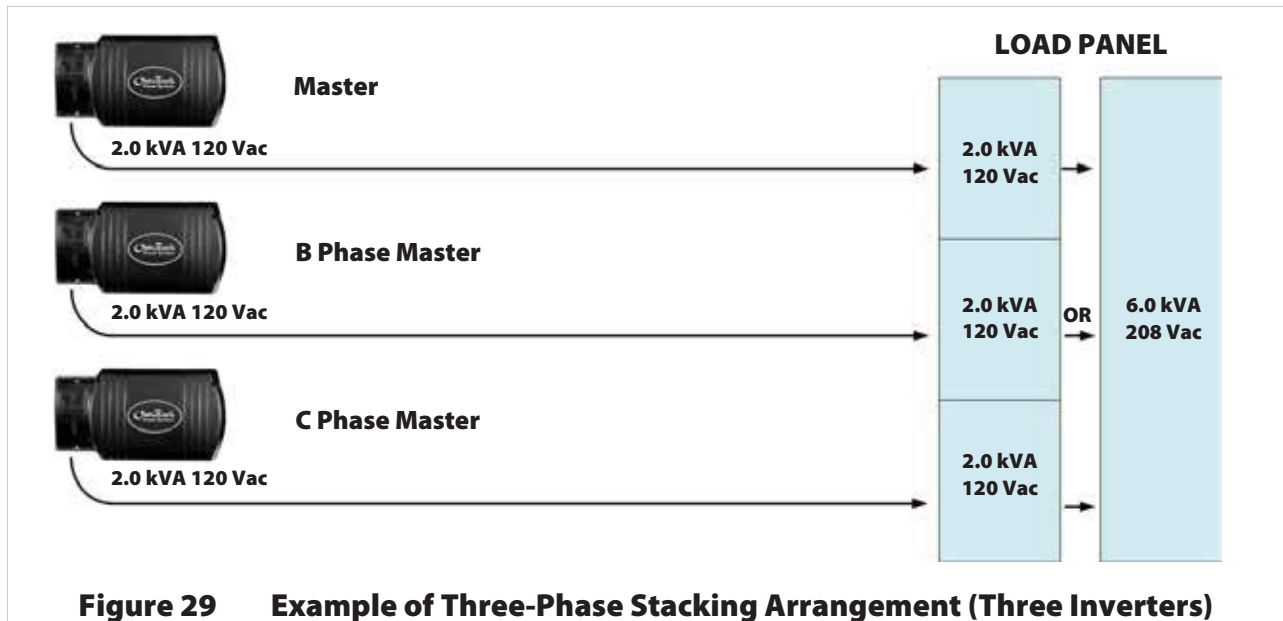

Figure 28 Series/Parallel Wiring

Three-Phase Stacking

In three-phase stacking, inverters create three separate 120 Vac⁷ output phases in a wye configuration.

- The three phases (A, B, and C) operate independently of each other. The inverters on one phase cannot assist another. Several inverters can be installed in parallel on one phase to power all 120 Vac loads on that phase.
- The output of each inverter is 120° out of phase from the others. Any two outputs produce 208 Vac between them. The outputs can be used to power three-phase loads when all inverters work together.
- Up to nine inverters, three per phase, may be installed in a three-phase arrangement. (The wiring drawing on the next page shows only one inverter per phase.) All inverters must be the same model.



⁷ Output voltages may vary with regional voltage standards.
900-0166-01-00 Rev B

Installation

When installing a three-phase system, observe the following rules.

- Three-phase stacking requires both the system display and the communications manager. See the HUB10.3 literature for any required jumper configurations.
- The inverter that is mounted physically lowest is always master and is programmed as **Master**.  Mounting below the other inverters allows the master to avoid heat buildup and remain relatively cool as it sees the greatest duty cycle.
- The master must be connected to port 1 of the communications manager. Other inverters must not be selected as master.
- Any other inverter on the Phase A output (parallel with the master) should be selected as **Slave** during programming. These can be connected to ports 2 or 3. Phase A inverters cannot use other ports.
- The subphase master for the Phase B output must be programmed as **B Phase Master**. It must be connected to port 4.
- Any other inverter on the Phase B output (parallel with the B subphase master) should be selected as **Slave** during programming. These can be connected to ports 5 or 6. Phase B inverters cannot use other ports.
- The subphase master for the Phase C output must be programmed as **C Phase Master**. It must be connected to port 7.
- Any other inverter on the Phase C output (parallel with the C subphase master) should be selected as **Slave** during programming. These can be connected to ports 8, 9, or 10. Phase C inverters cannot use other ports.
- All overcurrent devices must be sized for 60 Aac or less. All wiring must be sized for 60 Aac or more.
- All output circuit breakers must be sized appropriately for loads and inverter power.
- The AC input (generator or utility grid) must be a three-phase wye configuration source of the proper voltage and frequency.
- When wiring the AC source to the inverters, local codes may require the inverter circuits to be located at the opposite end of the panel from the main circuit breaker. This prevents overloading of the AC bus.

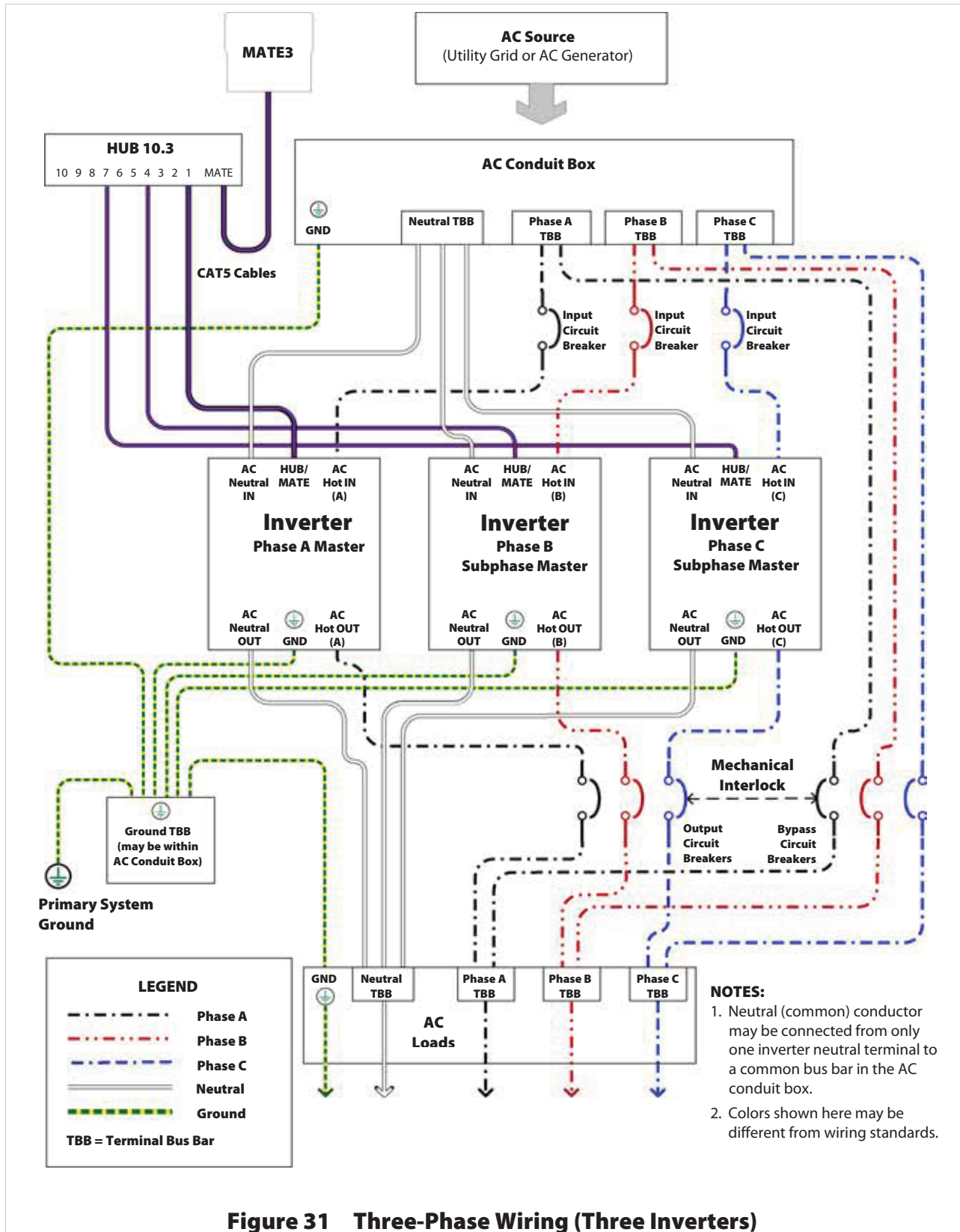

Figure 31 Three-Phase Wiring (Three Inverters)



Commissioning

Functional Test



WARNING: Shock Hazard and Equipment Damage

The inverter's AC and DC covers must be removed to perform these tests. The components are close together and carry hazardous voltages. Use appropriate care to avoid the risk of electric shock or equipment damage.

It is highly recommended that all *applicable* steps be performed in the following order. However, if steps are inapplicable, they can be omitted.

If the results of any step do not match the description, see the Operator's Manual for troubleshooting.

Pre-startup Procedures

1. Ensure all DC and AC overcurrent devices are opened, disconnected, or turned off.
2. Double-check all wiring connections.
3. Confirm that the total load does not exceed the inverter's rated power.
4. Inspect the work area to ensure tools or debris have not been left inside.
5. Using a digital voltmeter (DVM) or standard voltmeter, verify battery voltage. Confirm the voltage is correct for the inverter model. Confirm the polarity.
6. Connect the system display, if present.



CAUTION: Equipment Damage

Incorrect battery polarity will damage the inverter. Excessive battery voltage also may damage the inverter. This damage is not covered by the warranty.



IMPORTANT:

Prior to programming (see Startup), verify the operating frequency of the AC source. This is necessary for correct AC operation. The default setting is 60 Hz, but this can be changed to 50 Hz.

Startup

To start a single-inverter system:

1. Close the main DC circuit breakers (or connect the fuses) from the battery bank to the inverter. Confirm that the system display is operational, if present. 

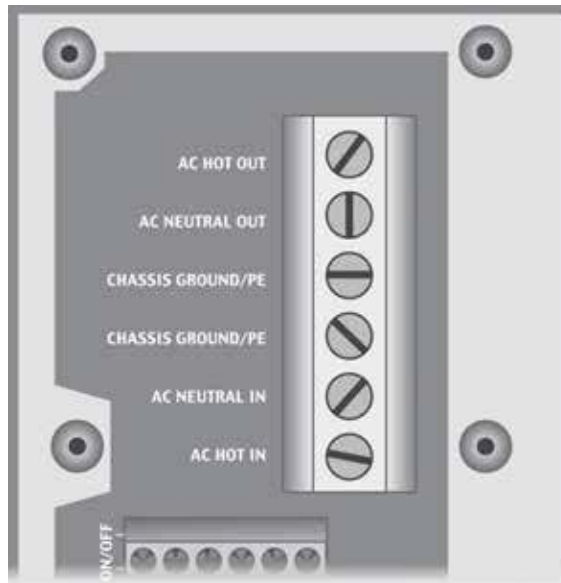



Figure 32 AC Terminals

2. If a system display is present, perform all programming for all functions. 
These functions may include AC input modes, AC output voltage, input current limits, battery charging, generator starting, and others.
3. Turn on the inverter using the system display (or external switch, if one has been installed). The inverter's default condition is Off. Do not turn on any AC circuit breakers at this time.
4. Using a DVM or voltmeter, verify 120 Vac (or appropriate voltage) between the AC HOT OUT and AC NEUTRAL OUT terminals. (See Figure 32 for AC terminals.) The inverter is working correctly if the AC output reads within 10% of 120 Vac or the programmed output voltage.

Proceed past the items below to Step 5 on the next page.

To start a multiple-inverter (stacked) system:

1. Close the main DC circuit breakers (or connect the fuses) from the battery bank to the inverter. Repeat for every inverter present. Confirm that the system display is operational.

With the system display, perform any programming for stacking and all other functions. 
These functions may also include AC input modes, AC output voltage, input current limits, battery charging, generator starting, and others. When stacking in parallel, all slave inverters will observe the master programming settings. They do not need to be programmed individually. The MATE3 Configuration Wizard may be used to assist programming.

2. Turn on the master inverter using the system display (or external switch, if one has been installed). The inverter's default state is Off. Do not turn on any AC circuit breakers at this time.
3. Using the system display, temporarily bring each slave out of Silent mode by raising the Power Save Level of the master.
 - As each slave is activated, it will click and create an audible hum.
 - Confirm that the system display shows no fault messages.
4. Using a DVM or voltmeter, verify appropriate voltage between the AC HOT OUT terminal on the master inverter and the AC HOT OUT terminal on each slave. Series inverters should read

within 10% of 120 Vac or the programmed output voltage. Parallel inverters should read close to zero. Three-phase inverters should read within 10% of 208 Vac or the designated output voltage.

- When this test is finished, return the master to its previous Power Save Level.

After output testing is completed, perform the following steps:

5. Close the AC output circuit breakers. If AC bypass switches are present, place them in the normal (non-bypass) position. Do not connect an AC input source or close any AC input circuits.
6. Use a DVM to verify correct voltage at the AC load panel.
7. Connect a small AC load and test for proper functionality.
8. Close the AC input circuit breakers and connect an AC source.
 - Using a DVM or voltmeter, check the AC HOT IN and AC NEUTRAL IN terminals for 120 Vac (or appropriate voltage) from the AC source.
 - If a system display is present, confirm that the inverter accepts the AC source as appropriate for its programming. (Some modes or functions may restrict connection with the source. If one of these selections has been used for the system, it may not connect.) Check the system display indicators for correct performance.
9. If the charger is activated, the inverter will perform a battery charging cycle after powering up. This can take several hours. If restarted after a temporary shutdown, the inverter may skip most or all of the charging cycle. Confirm that it is charging as appropriate by using the system display.
10. Test other functions which have been enabled, such as generator start, selling, or search mode.
11. Compare the DVM's readings with the system display meter readings. If necessary, the system display's readings can be calibrated to match the DVM more accurately. Calibrated settings include AC input voltage, AC output voltage, and battery voltage.

Powering Down

These steps will completely isolate the inverter.

To remove power from the system:

1. Turn off all load circuits and AC input sources.
2. Turn off all renewable energy circuits.
3. Turn each inverter OFF using the MATE3 system display or external switch.
4. Turn off the main DC overcurrent devices for each inverter.

Adding New Devices

When adding new devices to the system, first turn off the system according to the Power Down instructions. After adding new devices, perform another functional test, including programming.

Firmware Updates



IMPORTANT:

All inverters will shut down during firmware updates. If loads need to be run while updating the firmware, bypass the inverter with a maintenance bypass switch. Communication cables must remain connected and DC power must remain on. Interrupted communication will cause the update to fail and the inverter(s) may not work afterward. Inverters automatically update one at a time beginning with the highest port. Each requires about 5 minutes.

Updates to the inverter's internal programming are periodically available at the OutBack website www.outbackpower.com. If multiple inverters are used in a system, all units must be upgraded at the same time. All units must be upgraded to the same firmware revision.



IMPORTANT:

All stacked FXR inverters must have the same firmware revision. If multiple stacked inverters are used with different firmware revisions, any inverter with a revision different from the master will not function. (See the stacking section on page 30.) The MATE3 will display the following message:

An inverter firmware mismatch has been detected. Inverters X, Y, Z⁸ are disabled. Visit www.outbackpower.com for current inverter firmware.

Operation

Once the mounting, wiring, and other installation steps are completed, proceed to the *FXR Series Inverter/Charger Operator's Manual*.

Refer to the system display manual for programming instructions and menus.

⁸ The port designations for the mismatched inverters are listed here.

Definitions

The following is a list of initials, terms, and definitions used with this product.



Table 6 Terms and Definitions

Term	Definition
AC	Alternating Current; refers to voltage produced by the inverter, utility grid, or generator
AC Plate	Inverter accessory to accommodate flexible cable when conduit is not used
AGS	Advanced Generator Start
AUX	Inverter's 12-volt auxiliary output
Communications manager	Multi-port device such as the OutBack HUB10.3; used for connecting multiple OutBack devices on a single remote display; essential for stacking inverters
CSA	Canadian Standards Association; establishes Canadian national standards and the Canadian Electrical Code, including C22.1 and C22.2
DC	Direct Current; refers to voltage produced by the batteries or renewable source
DCC	DC Cover; shields the DC terminal area on vented FXR inverters
DVM	Digital Voltmeter
ETL	Electrical Testing Laboratories; short for the company ETL Semko; refers to a certification issued by ETL to OutBack products indicating that they meet certain UL standards
GFDI	Ground Fault Detector Interruptor; a safety device for PV systems
GND	Ground; a permanent conductive connection to earth for safety reasons; also known as Chassis Ground, Protective Earth, and PE
Grid-interactive, grid-intertie, grid-tie	Utility grid power is available for use and the inverter is capable of returning (selling) electricity back to the utility grid
HUB10.3	An OutBack communications manager product; used for system stacking and coordination
Invert, inverting	The act of converting DC voltage to AC voltage for load use or other applications
LED	Light-Emitting Diode; refers to indicators used by the inverter and the system display
Master	An inverter which provides the primary output phase of a stacked system; other stacked inverters base their output and on/off state on the master
MATE3	An OutBack system display product, used for monitoring, programming and communicating with the inverter
NEU	AC Neutral; also known as Common
Neutral-to-ground bond	A mechanical connection between the AC neutral (Common) bus and the ground (PE) bus; this bond makes the AC neutral safe to handle
Off-grid	Utility grid power is not available for use
On-grid	Utility grid power is available for use (does not imply grid-interactive capability)
PV	Photovoltaic

Table 6 Terms and Definitions

Term	Definition
RE	Renewable Energy
RTS	Remote Temperature Sensor; accessory that measures battery temperature for charging
Slave	An inverter which adds additional power to the master or subphase master in a stacked system; a slave does not provide an output of its own
Split-phase	A type of utility electrical system with two "hot" lines that typically carry 120 Vac with respect to neutral and 240 Vac with respect to each other; common in North America
Subphase Master	An inverter which provides the output for additional phases of a stacked system; the output of a subphase master is based on the output of the master
System display	Remote interface device (such as the MATE3), used for monitoring, programming and communicating with the inverter; also called "remote system display"
Three-phase, 3-phase	A type of utility electrical system with three "hot" lines, each 120° out of phase; each carries the nominal line voltage with respect to neutral; each carries voltage with respect to each other equaling the line voltage multiplied by 1.732
Turbo Fan	External cooling fan used in place of the DCC on sealed FXR inverters
UL	Underwriters Laboratories; refers to a set of safety standards governing electrical products
Utility grid	The electrical service and infrastructure supported by the electrical or utility company; also called "mains", "utility service", or "grid"

Symbols Used

	<p>WARNING: Hazard to Human Life</p> <p>This type of notation indicates that the hazard could be harmful to human life.</p>
	<p>CAUTION: Hazard to Equipment</p> <p>This type of notation indicates that the hazard may cause damage to the equipment.</p>
	<p>IMPORTANT:</p> <p>This type of notation indicates that the information provided is important to the installation, operation and/or maintenance of the equipment. Failure to follow the recommendations in such a notation could result in voiding the equipment warranty.</p>



MORE INFORMATION

When this symbol appears next to text, it means that more information is available in other manuals relating to the subject. The most common reference is to the *Operator's Manual* for the appropriate inverter model. Another common reference is the system display manual.



Index

A

AC Plate.....	6
AC Terminals	9, 17, 23
AC Test Points.....	42
Adding New Devices	43
Advanced Generator Start (AGS).....	27
Applications	9
Automatic Generator Start	27
AUX Terminals	17
AXS Port.....	5

B

Battery Bank	11
Sizing.....	12
Battery Terminal Covers.....	6, 21

C

Commissioning	41
Communication Cables	17, 25, 30
Communications Manager	
Connections.....	17, 25, 30
Stacking.....	31, 33, 35, 37
Components	6
Conductor Size	
AC Conductors.....	23
DC Conductors	20
Ground Conductors	18
Control Wiring Terminal Block.....	17

D

DC Cover (DCC)	6, 15, 22
DC Terminals	17, 20, 21
Definitions.....	45
Dimensions.....	16
Diversion Control.....	26
Drawings	
General System Layout.....	9
Parallel-Stacked System.....	34
Series/Parallel System	35
Series-Stacked System	32
Single-Inverter System.....	29
Three-Phase System.....	39

DVM	15, 41, 42, 43
-----------	----------------

E

Emergency Power Off (EPO)	25
Environmental Requirements.....	15

F

Features.....	5
Firmware	44
Functional Test.....	41

G

Gen Alert	27
Generator.....	29, 31, 33, 35, 37
Applications	9, 24
Control	27, 28
Sizing	13
Type.....	13
GFDI	18, 45
Grid-Interactive	9, 45
Grounding	17, 18

H

HUB10.3.....	25, 30
--------------	--------

I

Ingress Protection (IP).....	15
Input Modes.....	10

J

Jumper	17, 25
--------------	--------

L

LED Indicators.....	17
Listings.....	5
Location.....	15

Index

M

Master (Stacking).....	30, 31, 33, 35, 37
MATE/HUB Port.....	25
MATE3.....	5, 25, 30, 46
Models.....	6
Modes.....	10
Mounting.....	16
Multiple AC Sources.....	24

N

Neutral-Ground Bonding.....	13, 18, 23
-----------------------------	------------

O

On and Off.....	17, 25
OPTICS RE.....	5

P

Parallel Stacking.....	33
Ports, RJ45 and RJ11.....	17, 25
Positive Grounding.....	18
Powering Down.....	43
PV9, 10.....	

R

Relative Humidity (RH).....	15
Remote Temperature Sensor (RTS).....	6, 17, 25
Renewable Energy.....	10

S

Sealed Models.....	6, 15
Series Stacking.....	31
Series/Parallel Stacking.....	35
Sizing.....	29
Slave (Stacking).....	30, 33, 35, 37
Stacking.....	30, 44
Commissioning.....	42
Parallel.....	33
Series.....	31
Series/Parallel.....	35
Three-Phase.....	37
Stacking Mode Programming.....	31
Startup.....	41
Subphase Master (Stacking).....	30, 31, 35, 37

Symbols Used.....	46
System Display.....	44, 46
Connections.....	17, 25
Programming.....	13, 26, 27, 30
Stacking.....	31, 33, 35, 37

T

Temperatures.....	15
Terms and Definitions.....	45
Test.....	41
Test Points.....	42
Three-Phase Stacking.....	37
Tools Required.....	15
Torque Requirements.....	
AC Terminals.....	23
DC Terminals.....	20
Ground Terminals.....	18
Transformer.....	13
Turbo Fan.....	6, 22

U

Updating Firmware.....	44
Utility Grid.....	29, 31, 33, 35, 37
Applications.....	9, 24

V

Vent Fan.....	26
Vented Models.....	6, 15

W

Website.....	44
Wiring.....	18
AC Connections.....	23
AUX Connections.....	26
DC Connections.....	20
Ground Connections.....	18
Single Inverter.....	29
Stacking.....	
Parallel.....	34
Series.....	32
Series/Parallel.....	35
Three-phase.....	39

X

XCT.....	17
----------	----

This page intentionally left blank.

This page intentionally left blank.

This page intentionally left blank.



Masters of the Off-Grid.™ First Choice for the New Grid.

Corporate Headquarters
17825 – 59th Avenue N.E.
Suite B
Arlington, WA 98223 USA
+1.360.435.6030

European Office
Hansastraße 8
D-91126
Schwabach, Germany
+49.9122.79889.0