



**FX AND VFX SERIES
INVERTER/CHARGER**
Programming Manual

Warranty Summary

Dear OutBack Customer,

Thank you for your purchase of OutBack products. We make every effort to assure our power conversion products will give you long and reliable service for your renewable energy system.

As with any manufactured device, repairs might be needed due to damage, inappropriate use, or unintentional defect. Please note the following guidelines regarding warranty service of OutBack products:

- Any and all warranty repairs must conform to the terms of the warranty.
- All OutBack equipment must be installed according to their accompanying instructions and manuals with specified over-current protection in order to maintain their warranties.
- The customer must return the component(s) to OutBack, securely packaged, properly addressed, and shipping paid. We recommend insuring your package when shipping. Packages that are not securely packaged can sustain additional damage not covered by the warranty or can void warranty repairs.
- There is no allowance or reimbursement for an installer's or user's labor or travel time required to disconnect, service, or reinstall the damaged component(s).
- OutBack will ship the repaired or replacement component(s) prepaid to addresses in the continental United States, where applicable. Shipments outside the U.S. will be sent freight collect.
- In the event of a product malfunction, OutBack cannot bear any responsibility for consequential losses, expenses, or damage to other components.
- Please read the full warranty at the end of this manual for more information.

About Outback Power Systems

OutBack Power Systems is a leader in advanced energy conversion technology. Our products include true sine wave inverter/chargers, maximum power point charge controllers, system communication components, as well as breaker panels, breakers, accessories, and assembled systems.

Notice of Copyright

FX Series Inverter/Charger Programming Manual © 2007 All rights reserved.

Disclaimer

UNLESS SPECIFICALLY AGREED TO IN WRITING, OUTBACK POWER SYSTEMS:

(a) MAKES NO WARRANTY AS TO THE ACCURACY, SUFFICIENCY OR SUITABILITY OF ANY TECHNICAL OR OTHER INFORMATION PROVIDED IN ITS MANUALS OR OTHER DOCUMENTATION.

(b) ASSUMES NO RESPONSIBILITY OR LIABILITY FOR LOSS OR DAMAGE, WHETHER DIRECT, INDIRECT, CONSEQUENTIAL OR INCIDENTAL, WHICH MIGHT ARISE OUT OF THE USE OF SUCH INFORMATION. THE USE OF ANY SUCH INFORMATION WILL BE ENTIRELY AT THE USER'S RISK.

Contact Information:

OutBack Power Systems

19009 62nd Ave. NE• Arlington, WA 98223 Phone (360) 435-6030 • Fax (360) 435-6019

www.outbackpower.com

Date and Revision • July 2008 REV B

TABLE OF CONTENTS

Warranty Summary.....	1
Welcome to the OutBack Power Systems FX Series Inverter/Charger System	4
Safety.....	4
Modes and Properties	5
SETUP Screens	5
SEARCH Mode	6
INPUT Menu.....	7
ADVANCED Screens	9
INVERTER Menu	10
CHARGER Menu	13
GENERATOR Menu	16
FX Series Inverter/Charger Programming.....	19
Concerns.....	19
Options.....	19
Components and Connections.....	20
Stacking Options.....	23
OutBack Parallel.....	23
Classic Series.....	23
OutBack Series.....	24
OutBack Series Parallel.....	24
3-Phase.....	25
Stacking and Assigning FX Status.....	25
1-2ph Master.....	26
Classic Slave.....	26
OB Slave L1.....	26
OB Slave L2.....	26
3ph Master.....	26
3ph Slave.....	26
Programming the FXs.....	27
1-2 ph Master.....	30
OutBack (OB) Slave.....	30
OutBack (OB) Slave 2.....	31
3-Phase (3-ph) Master.....	31
3-Phase (3-ph) Slave.....	32
Introduction to Power Save Levels.....	33
Stacking System Examples	37
OutBack Parallel Stacking.....	38
Ranking the Slaves.....	39
OutBack Series/Parallel Stacking.....	41
Ranking the Slaves.....	44
3-Phase Stacking.....	46

Auxiliary (AUX) Functions.....	47
List of AUX Functions.....	50
Adjustable AUX Output Functions.....	50
Battery Charging Function	53
Maintenance.....	53
FX Default Values.....	54
Warranty.....	55
Product Registration.....	58

Welcome to the OutBack Power Systems FX Series Inverter/Charger System

The FX Series Inverter/Charger offers a complete power conversion system—DC to AC, battery charging, and an AC Transfer Relay—and can be used for stand-alone or back-up applications.

OutBack Power Systems does everything possible to assure the components you purchase will function properly and safely when installed as instructed according to local and national electrical codes. Please read all of the instructions and the instructions that come with any OutBack components included in your power system. Instructions on individual FX set-ups as well as systems assemblies are included with the *FX and VFX Series Inverter/Charger Installation Manual*.

The OutBack Power Systems FX Series Inverter/Charger is ETL listed to UL1741 (Inverters, Converters, Controllers, and Interconnection System Equipment for Use with Distributed Energy Resources). All Mobile FX Series Inverter/Chargers are ETL listed to UL 458.

Grounding Instructions – Each FX should be connected to a grounded, permanent wiring system. For most installations, the negative battery conductor should be bonded to the grounding system at one (and only one) point in the DC system. All installations must comply with all national and local codes and ordinances. System grounding as required by the National Electric Code, ANSI /NFPA 70-1996, is the responsibility of the system installer.

The equipment ground is marked with this symbol: 

The *FX and VFX Series Inverter/Charger Programming Manual* covers the following information:

- Safety
- Programming or “stacking” multiple FXs using the OutBack Power Systems MATE

IMPORTANT SAFETY INSTRUCTIONS

SAVE THESE INSTRUCTIONS

General Precautions:

1. Use caution whenever working around electricity, electrical components, and batteries. There is always a potential for shocks, burns, injury, and even death if an installer or user comes in contact with electricity.
2. Read all instructions and cautionary markings on the FX, the batteries and all appropriate sections of this manual as well as other component manuals before using the system.
3. Be sure each FX is securely installed according to the *FX and VFX Series Inverter/Charger Installation Manual*.
4. Follow all local and national electrical codes when installing OutBack equipment and components.

FX MODES AND PROPERTIES

Each OutBack FX Inverter/Charger comes with various default values set at the factory. Typically, a single FX installation will retain these values, but multiple FXs will require programming using the OutBack MATE. Viewing the status of an FX and adjusting its functions also requires a MATE.

SETUP SCREENS

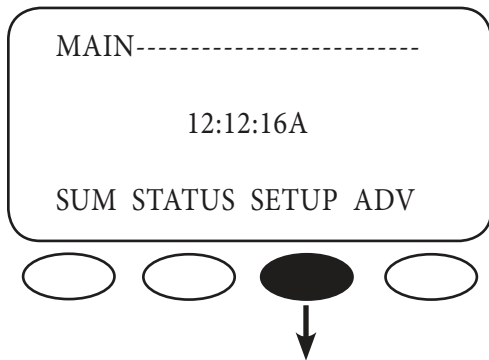

From the MAIN screen, press **SETUP**

NOTE: Pressing and holding the first two soft keys at the same time will always bring up the MAIN Menu screen.

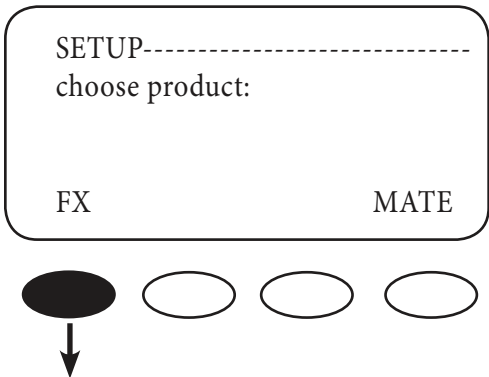

Press **FX**

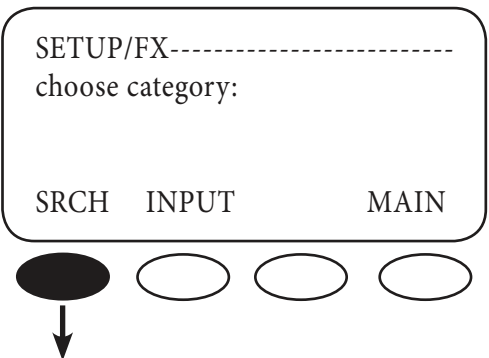

Two choices are available in the choose category screen:

- Search (SRCH) which adjusts the search mode settings
- INPUT which for selecting the AC INPUT and current limit adjustment

Press **SRCH** to open the search screens.

SEARCH MODE

An FX consumes a small amount of power when it is not actively supplying power to loads or for battery recharging. During this SEARCH MODE, the FX sends out AC pulses to sense load demands. Once a large enough load is sensed, the FX turns ON and provides AC power. Using SEARCH mode, a user can adjust the FX so it only comes ON for certain size loads and not for smaller ones. The SEARCH features are mainly used in off-grid systems to conserve power.

NOTE: Some loads will require experimenting with the SEARCH settings.

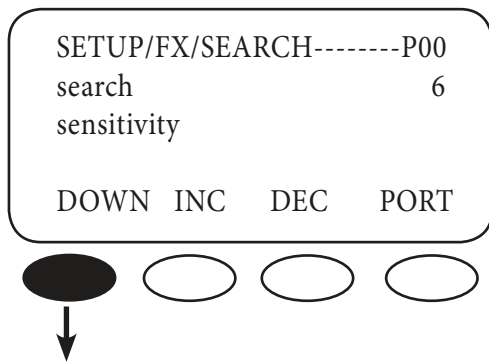

Use the *search sensitivity* screen to determine the size of an AC load needed for the FX to turn ON and leave SEARCH mode.

- Pressing **INC** decreases sensitivity (a bigger load is needed to turn the FX on)
 - Pressing **DEC** increases the sensitivity which means a smaller load (less wattage) will turn the FX on
 - Decreasing to zero disables SEARCH mode
- Press **DOWN** to view the next SEARCH screen.

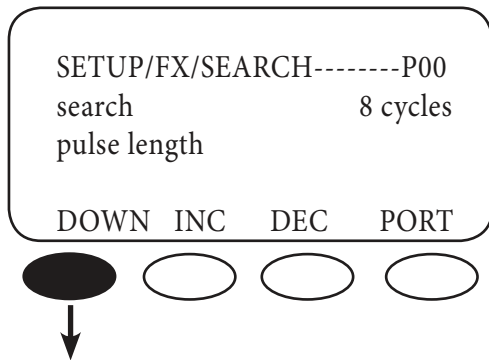

The FX produces pulses to detect AC loads. The *search pulse length* screen allows adjusting the number of pulses (from 4 to 20) or cycles to more reliably detect AC loads. A setting of 8 or higher, adjusted using **INC** and **DEC**, is recommended. Press **DOWN** to open the *search pulse spacing* screen.

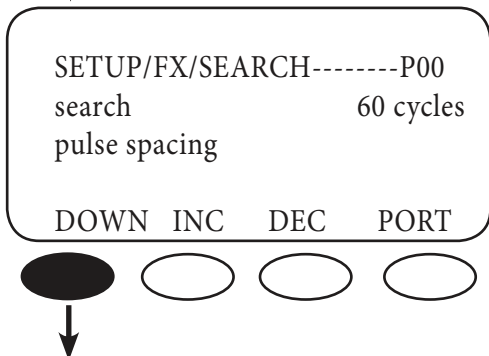

The *search pulse spacing* screen adjusts the amount of time the FX waits before producing additional AC pulses to sense a load. The higher the number of cycles, the lower the FX power consumption, but the longer it takes before the AC load is powered. The cycles range from 4 to 120 cycles (two seconds). Press **DOWN** to complete the SEARCH menu.

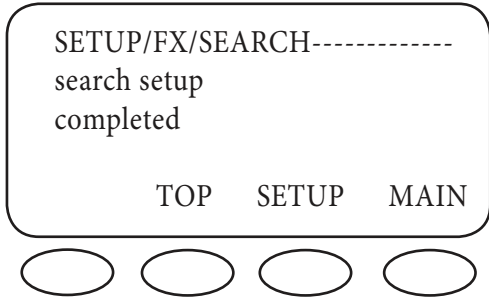

Pressing **TOP** returns you to the SETUP/FX/SEARCH screen.

Pressing **SETUP** returns the user to the *choose category* screen.

Pressing **MAIN** returns to the MAIN Menu.

INPUT MENU

The INPUT screens allow the user to choose either grid or generator AC input and the maximum amperage from either source that can pass through the FX before a warning occurs.

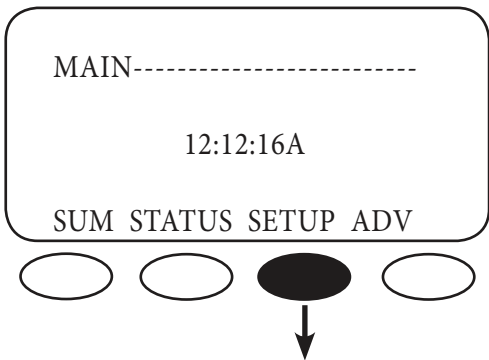

From the MAIN screen, press **SETUP**.

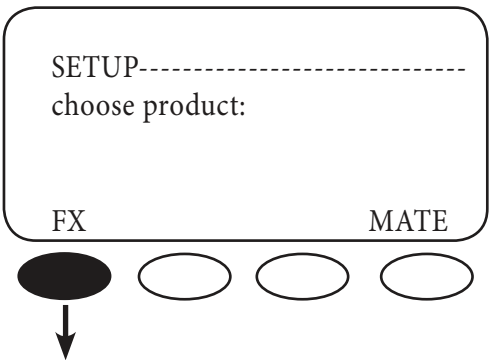

Press **FX**.

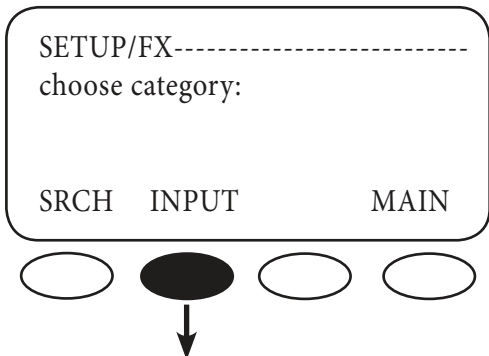

Two choices are available in the choose category screen:

- Search (SRCH) which adjusts the search mode settings
- INPUT which for selecting the AC INPUT and current limit adjustment

Press **INPUT**.

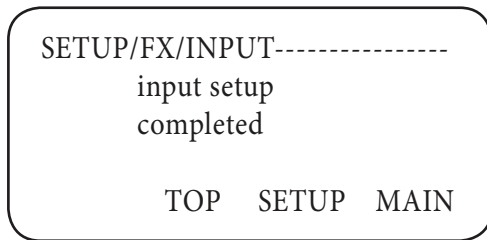
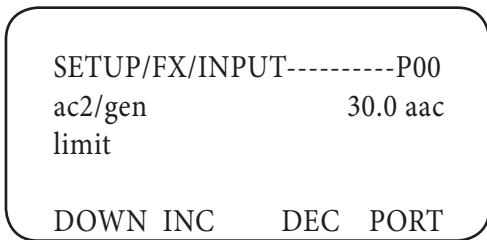
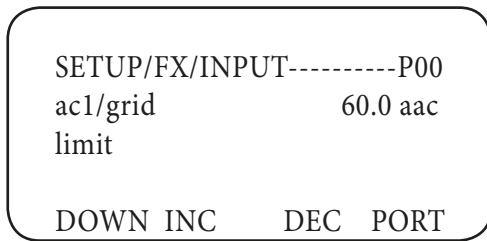
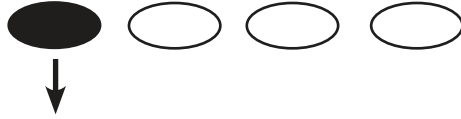
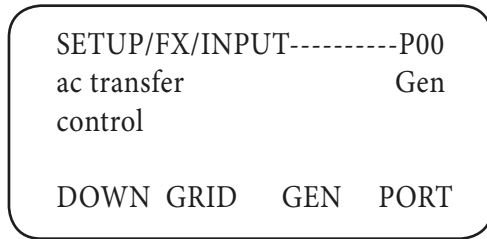

To choose your AC input source in the *ac transfer control* screen, press **GRID** or **GEN**. Press **DOWN** to view the next screen.

By using **INC** and **DEC**, the *ac1/grid* menu sets the maximum current the FX will allow to be drawn from the grid by either AC loads or the batteries (during recharging). When this limit is exceeded, the FX will reduce the amount of charging current passing through it to the maximum setting (between 5.0AAC and 60.0AAC). Press **DOWN** to view the next INPUT screen.

The *ac2/gen limit* screen sets the maximum current the FX will allow to be drawn from a generator by either AC loads or the batteries (during recharging). When this limit is exceeded, the FX will reduce the amount of charging current passing through it to the maximum setting (between 2.0AAC and 30.0AAC) to avoid damage to the generator. Press **DOWN** to view the final INPUT screen.

Pressing **TOP** returns you to the SETUP/FX/SEARCH screen.

Pressing **SETUP** returns the user to the *choose category* screen.

Pressing **MAIN** returns to the MAIN Menu.

ADVANCED SCREENS

All the FX operation settings can be adjusted in the MATE's ADVANCED screens, including some previously discussed in the INPUT and SETUP menus. Changing the settings under any menu will affect the values in all menus. The ADVANCED screens are accessed via the password 141.

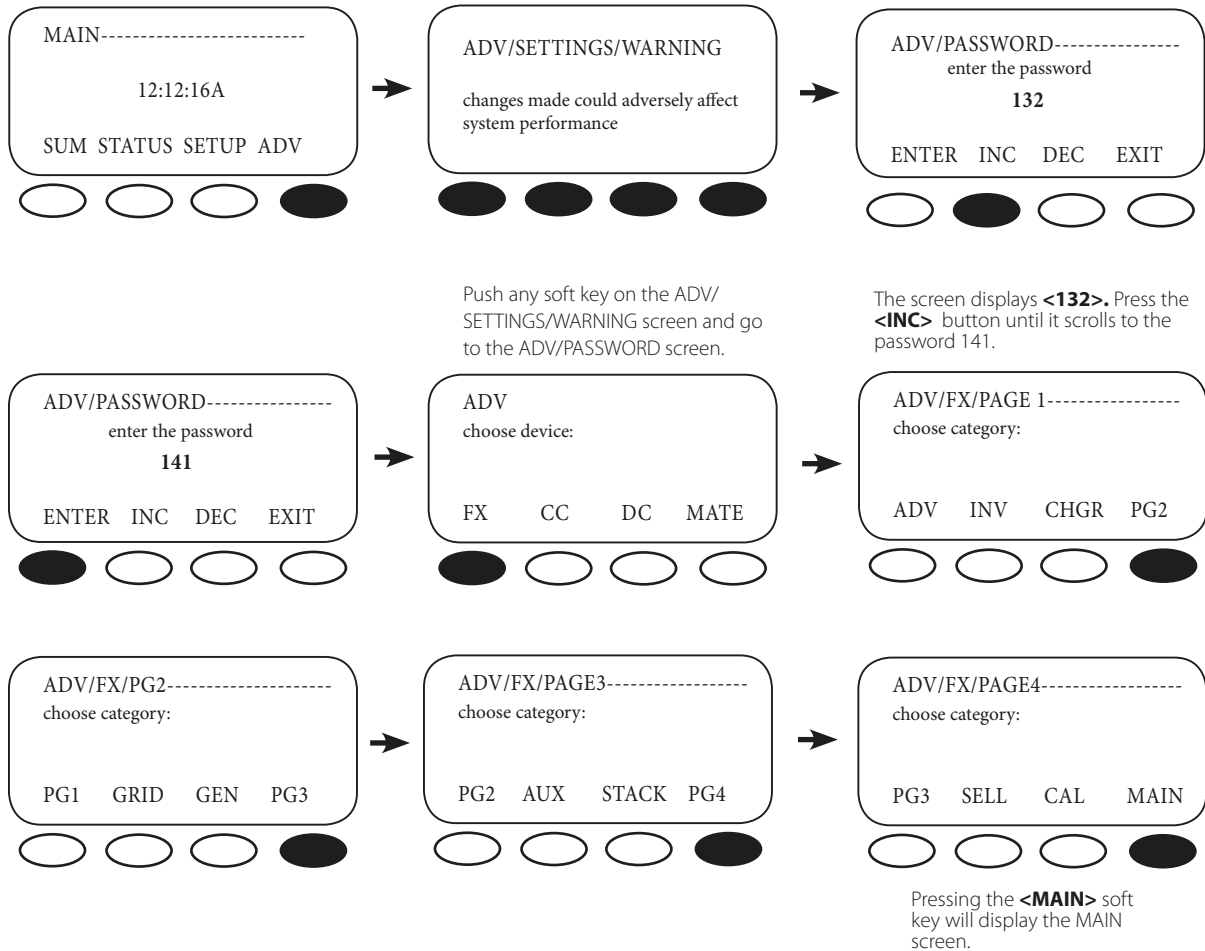

The FX settings and their adjustments include:

- INV—INVERTER
- CHGR—CHARGER
- GRID—AC input if the FX input is set to GRID
- GEN—AC input if the FX input is set to GEN
- AUX—AUX OUTPUT
- STACK—Master and Slave designations when multiple FXs are in use
- SELL—Grid-Interactive FX operations
- CAL—Adjusts voltage calibration measurements for improved operation

INVERTER MENU

The INVERTER screens allow adjusting the inverter's operations to match the AC load and battery recharging requirements, including the search functions, low-battery cut-out, the FX's output voltage, and resetting the FX to its factory default values.

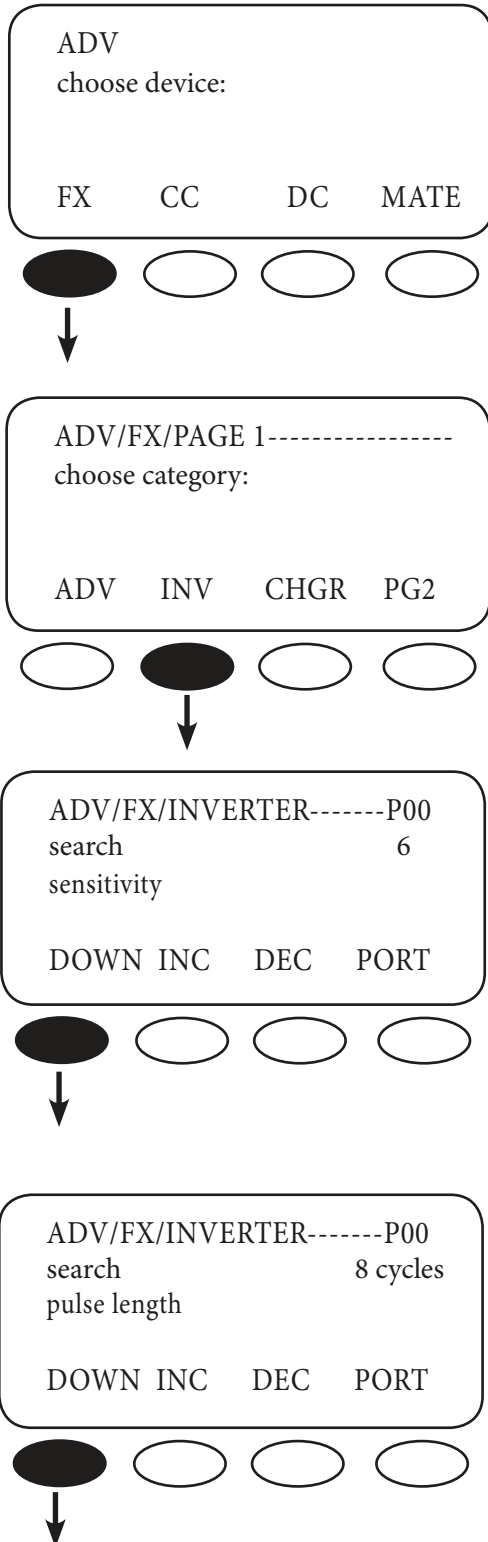

After entering the ADVANCED screens, press **FX** on the *choose device* screen.

Press **INV**.

Use the *search sensitivity* screen to determine the size of an AC load needed for the FX to turn ON and leave SEARCH mode.

- Pressing **INC** decreases sensitivity (a bigger load is needed to turn the FX on)
 - Pressing **DEC** increases the sensitivity which means a smaller load (less wattage) will turn the FX on
 - Decreasing to zero disables SEARCH mode
- Press **DOWN** to view the *search pulse length* screen.

The FX produces pulses to detect AC loads. The *search pulse length* screen allows adjusting the number of pulses (from 4 to 20) or cycles to more reliably detect AC loads. A setting of 8 or higher, adjusted using **INC** and **DEC**, is recommended. Press **DOWN** to open the *search pulse spacing* screen.

ADV/FX/INVERTER-----P00
search pulse spacing 60 cycles
DOWN INC DEC PORT



ADV/FX/INVERTER-----P00
low battery cut-out set point 10.5 vdc
DOWN INC DEC PORT



ADV/FX/INVERTER-----P00
low battery cut-in set point 12.5 vdc
DOWN INC DEC PORT



ADV/FX/INVERTER-----P00
adjust output voltage 120 vac
DOWN INC DEC PORT

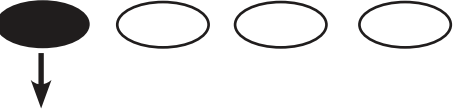

The *search pulse spacing* screen adjusts the amount of time the FX waits before producing additional AC pulses to sense a load. The higher the number of cycles, the lower the FX power consumption, but the longer it takes before AC loads are powered. The cycles range from 4 to 120 cycles (two seconds). Press **DOWN** to view the *low battery cut-out* screen.

low battery cut-out establishes when the FX turns off to avoid draining the battery. If an AC source is available and AC INPUT is set to DROP, the FX will transfer the AC loads on the FX to the AC source. A built-in five-minute delay reduces nuisance FX shutdowns. This setting's range is between 9.0VDC and 12.0VDC. Press **DOWN** to view the next INVERTER screen.

The *low battery cut-in set point* determines when the FX will turn on after shutting off due to a low battery voltage. A 10-minute fixed delay reduces on and off system cycling. This setting's range is between 10.0 VDC and 14.0 VDC. Press **DOWN** to view the *adjust output voltage* screen.

A user can adjust the *output voltage* using this screen. Adjustments might be necessary if some loads are far away from the FX or if some are sensitive to higher voltages. This setting's range is between 110VAC and 125VAC. Press **DOWN** to view the next INVERTER screen.

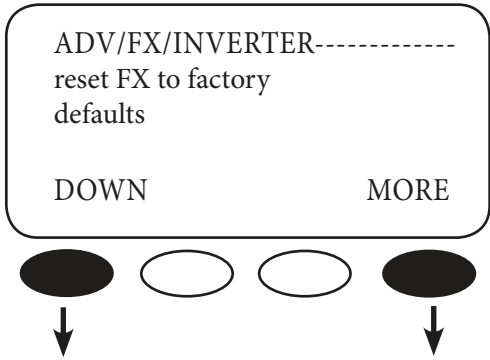

Use this screen to reset the FX to its factory default set points. This will cause all previous programming changes to be lost. Press **MORE** to choose the HUB port whose FX is to be reset and then press **PORT** or, if no HUB is in use, press **NEXT**. Press **DOWN** to skip resetting to factory defaults.

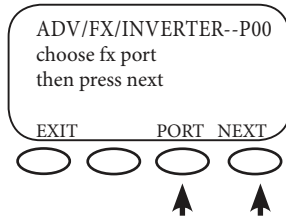

To reset to factory defaults, press **PORT** if a HUB is used until the chosen port number appears or press **NEXT** if this is a single FX system.

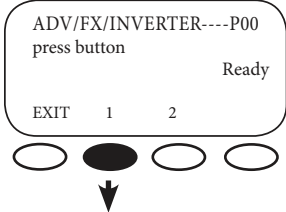

To complete the reset, press **1** and then **2**.

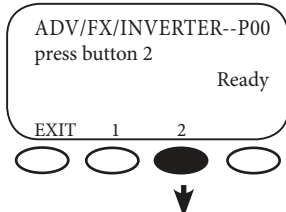

Press **EXIT** to exit the INVERTER screens.

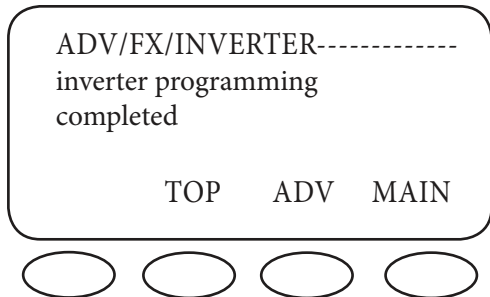
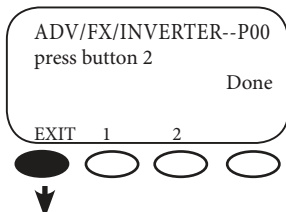

Pressing **TOP** returns to the beginning of the ADV/FX/INVERTER menu.

ADV returns to the ADVANCED screens and **MAIN** displays the MAIN screen.

CHARGER MENU

Each battery manufacturer has specific recharging directions and guidelines. OutBack's default values work for many batteries, but might not be the ideal settings. The CHARGER Menu allows these settings to be adjusted. to the manufacturer's recommendations.

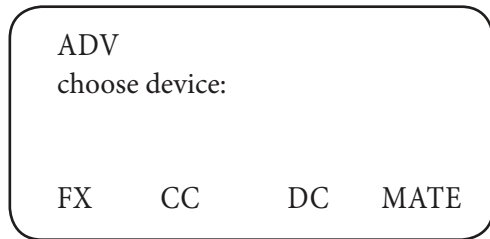

From the ADVANCED menu, press **FX** .

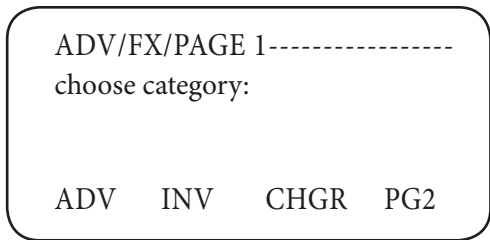

Press **CHGR** .

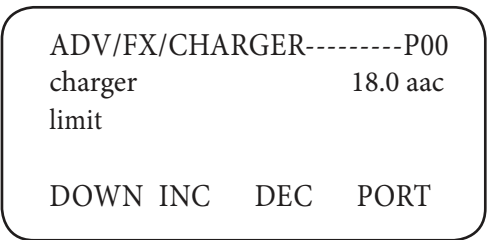

The *charger limit* is the maximum AC current the FX uses to charge the batteries. Depending on the FX model, the setting range is as low as 0.0 AAC to between 12.0AAC and 20.0AAC using **INC** and **DEC** . Press **DOWN** to continue in the CHARGER Menu.

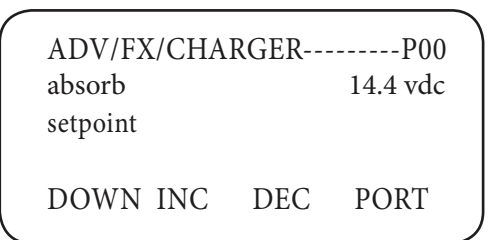

The *absorb set point* is the first stage (BULK) recharging voltage for the batteries. This set point ranges from 13.0VDC to 16.0VDC as determined using **INC** and **DEC** . Press **DOWN** to view the *absorb time limit* screen.



ADV/FX/CHARGER-----P00
 absorb 01.0 hrs
 time limit
 DOWN INC DEC PORT

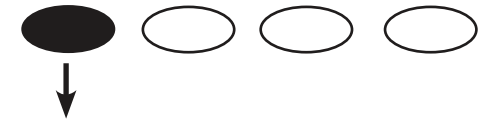

ADV/FX/CHARGER-----P00
 float 13.6 vdc
 setpoint
 DOWN INC DEC PORT



ADV/FX/CHARGER-----P00
 float 01.0 hrs
 time period
 DOWN INC DEC PORT



ADV/FX/CHARGER-----P00
 refloat 12.2vdc
 set point
 DOWN INC DEC PORT



The *absorb time limit* must be long enough for the batteries to regain 95-100% of their charge. This time limit can be set between 0 hours and 24 hours using **INC** and **DEC**. The FX automatically reduces this limit when it's connected to a partially charged battery. Press **DOWN** to continue in the CHARGER Menu.

The *float set point* is the batteries' finishing charge which completes the recharging process. This setting ranges from 12.0VDC to 15.0VDC. Press **DOWN** to continue.

The *float time period* is the amount of time—from 0 to 24 hours—the recharging process maintains the *float set point*. Larger batteries will probably require more time than smaller batteries. The recharging stops when the *float time period* is satisfied. Press **DOWN** to view the next screen.

When the battery voltage falls below the *refloat set point*, a float cycle recharging starts. This can act as a maintenance recharging or a recharging when intermittent DC loads are running and an AC source is available for recharging. This setting ranges between 12.0VDC and 13.0VDC. Press **DOWN** to view the next CHARGER screen.

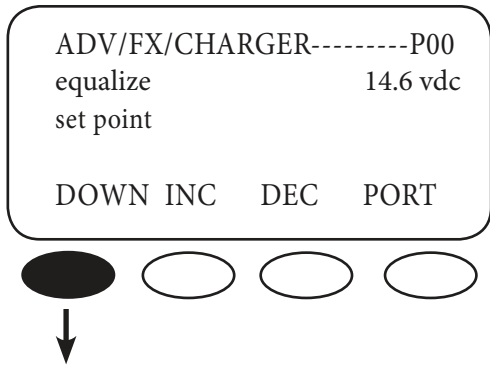

An occasional equalize charge helps destratify the batteries for a longer working life. Pressing the **AC IN** hot key leads to screens that begin the EQ charging voltage. The *equalize set point* determines the recharging voltage, which can range between 14.0 VDC and 17.0 VDC (consult your battery manufacturer for a specific volage) using **INC** and **DEC**. An equalize recharging should be supervised until completed. Press **DOWN** to continue.

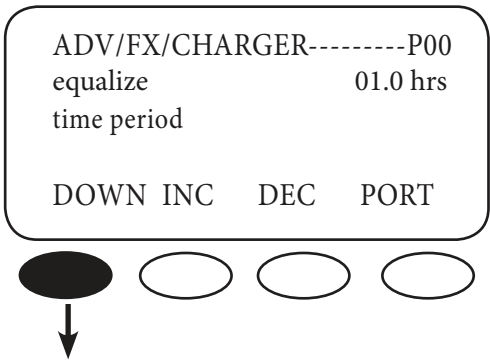

The *equalize time period* limits the equalizing recharge time. The timer begins advancing once the battery voltage exceeds the *absorb voltage set point*. When the *equalize time period* is met, the recharging stops. It is adjustable between 0 hours and 24 hours using **INC** and **DEC**. Press **DOWN** to view the last CHARGER screen.

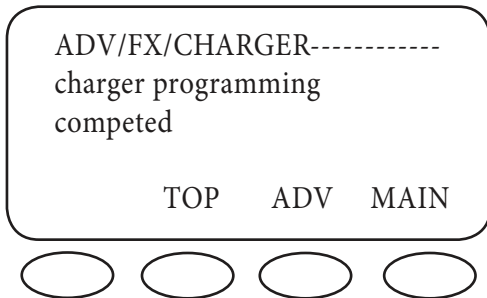

Pressing **TOP** returns to the first ADV/FX/CHARGER screen. Pressing **ADV** returns to the ADVANCED screen. Pressing **MAIN** brings up the MAIN screen.

GENERATOR MENU

OutBack off-grid and mobile FX Inverter/Chargers are programmed to use an AC generator as their default source of AC input. The CHARGER GEN screens allow a user to adjust the input voltage window and time delays of their AC input.

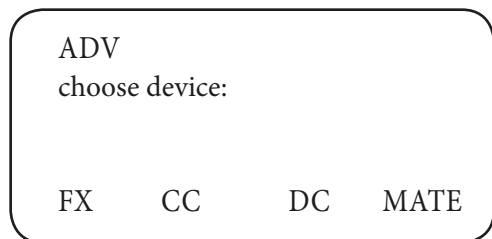

From the ADVANCED screen, press **FX**.

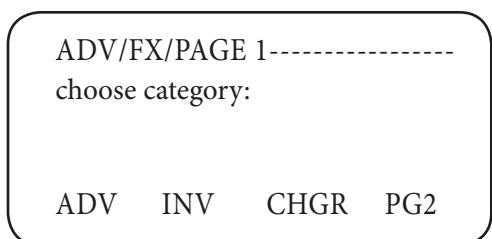

Press **PG2**.

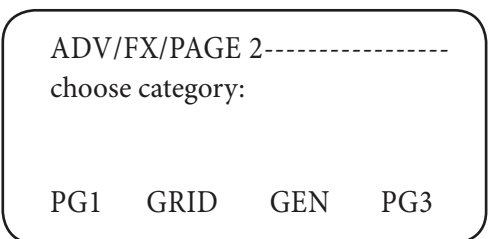

Press **GEN** to adjust the AC input set points and operation.

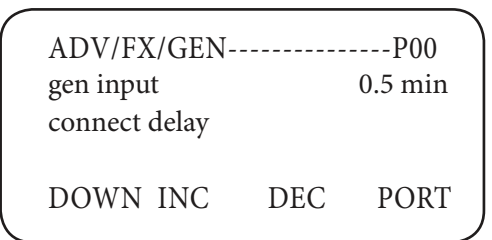

The *gen input connect delay* is the time period between the FX's recognizing an acceptable generator source of AC and connecting that source to AC loads. This delay allows the generator to warm up and has a range between 0.2 minutes and 15 minutes which are adjusted with **INC** and

DEC.

Press **DOWN** to view the next GEN screen.

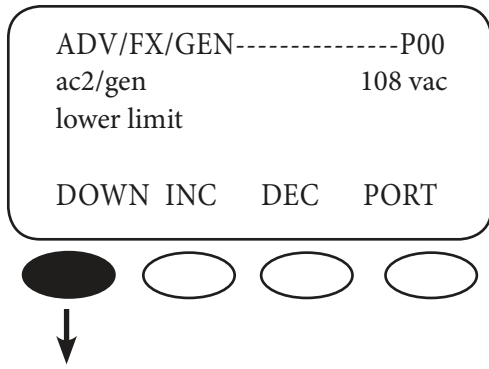

The *ac2/gen lower limit* is the lowest allowable voltage for the FX to connect to the generator. If the voltage falls below this limit, the FX will disconnect from the generator. This voltage value is adjusted using **INC** and **DEC** for values between 40VAC and 115VAC. Press **DOWN** to continue viewing the generator screens

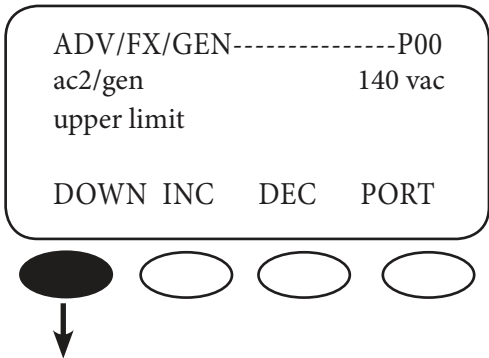

The *ac2/gen upper limit* is the highest allowable voltage for the FX to remain connected to the generator. If the voltage is higher than this limit, the FX will disconnect from the generator. This voltage value is adjusted using **INC** and **DEC** for values between 130 VAC and 150 VAC. Press **DOWN** to view the *ac2/gen input limit* screen.

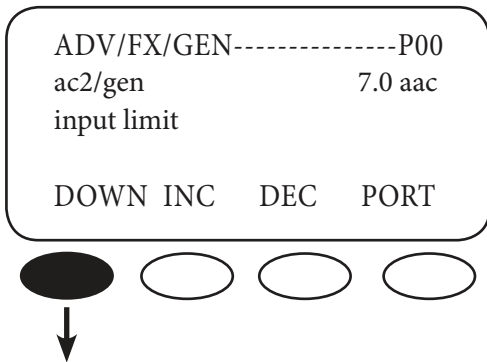

The *ac2/gen input limit* is the maximum current the FX can draw from a generator. When this limit is reached, the FX reduces its battery charging function to prevent overloading the generator. If the generator exceeds this limit, the FX will start blinking the red ERROR LED as a warning. This setting's range is 2.0AAC to 30.0AAC, adjustable using **INC** and **DEC**. Press **DOWN** to continue.

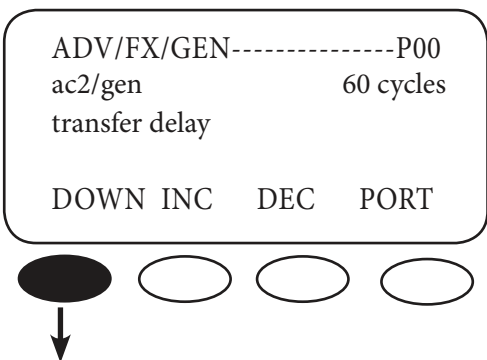

The *ac2/gen transfer delay* is the amount of time the FX remains connected to the generator after the AC input voltage drops below the *ac2/gen lower limit* setting. This setting is adjusted between 0 and 240 cycles using **INC** and **DEC**. Press the **DOWN** soft key to view the next GEN screen.

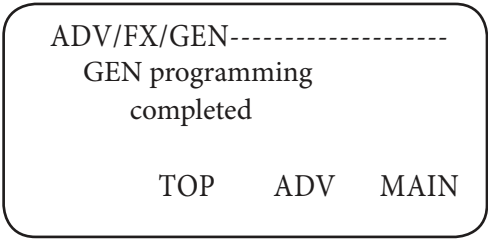
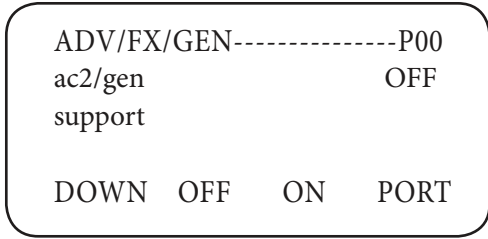

This feature is not operational at this time. Press **DOWN** to view the final GEN screen.

Pressing **TOP** returns to the beginning of the ADV/FX/INVERTER menu. **ADV** returns to the ADVANCED screens and **MAIN** displays the MAIN screen.

FX Series Inverter/Charger Programming

NOTE: Please see the *FX and VFX Series Inverter/Charger Installation Manual* to install, wire, and connect each FX Series Inverter/Charger. This programming manual assumes all FXs have been installed and are ready to program according to the way they were wired. If a different programming is desired, the FXs might require a different wiring configuration (see sample wiring diagrams in the *FX and VFX Series Inverter/Charger Installation Manual*). To familiarize yourself with the programming concepts, please read through the entire manual before programming your system.

Up to two grid-interactive FXs, ten off-grid FXs (including export models), or three FXs in a three-phase system can be combined and wired or “stacked” for systems requiring more power. A user’s final loads and power needs determine which stacking configuration will work best.

- Stacking FXs does not refer to physically placing one FX on top of another, but to how they are wired within the system and then programmed for operation. Stacking allows all the FXs to work together as a single system.
- Stacking assigns the FXs to power individual legs of the system and to operate at certain times; this order is assigned using the MATE.
- PLEASE NOTE: An OutBack MATE is required to recognize and program the FXs. When multiple FX’s are used, each needs to be assigned a status—Master or Slave.
- The Master FX is the primary and most heavily used unit. The loads and demands of the system determine when and which Slaves are used. A Slave FX assists when the load demands are more than the Master FX can handle alone.
- This is an orderly process as long as the user assigns each FX correctly. This is mainly a matter of paying attention to the Port number for each FX when programming with the MATE.

Stacking Concerns

FXs should be wired and stacked appropriately to their individual power system. Problems can occur when:

- An FX is incorrectly wired.
- An FX plugged into a HUB Port is mistakenly programmed (assigned the wrong status) or misidentified.
- An easy rule to remember is any FX wired to a specific phase or leg must be programmed to that phase.

Stacking Options

The FX Series Inverter/Chargers can be stacked in the following configurations (see page 7).

1. OutBack Parallel
2. Classic Series
3. OutBack Series
4. OutBack Series/Parallel
5. 3-Phase

Each stacking option has benefits and should be chosen according to a user’s needs and individual power system. Consult with your dealer or installer to determine what will work best for you.

Components and Connections

1. With all AC and DC breakers OFF, connect all FXs to the HUB with individual lengths of CAT5 cable.

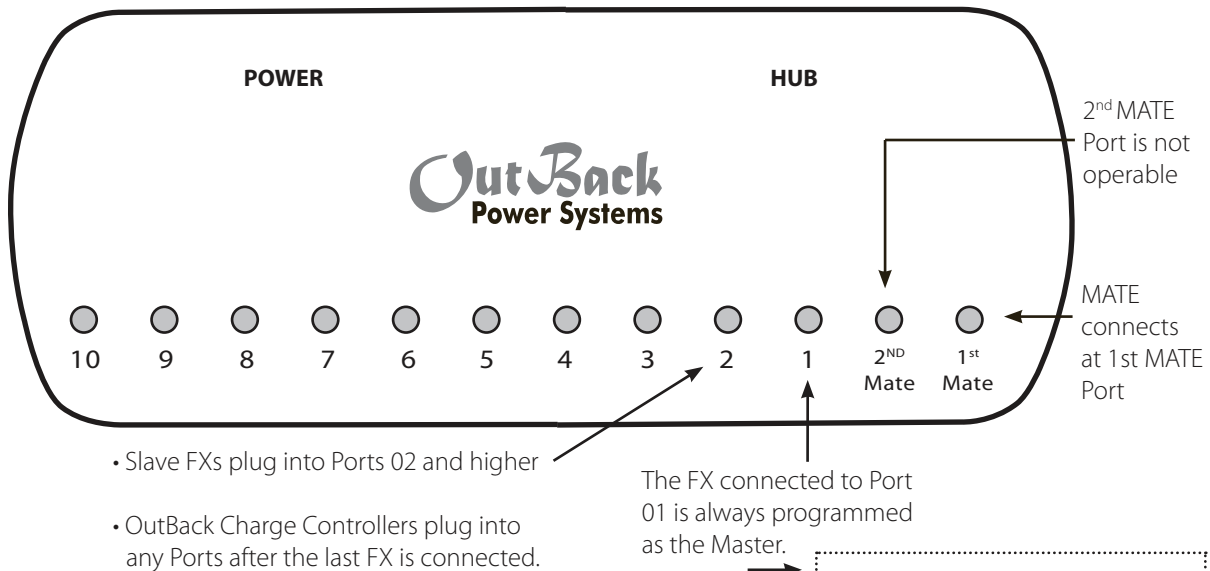
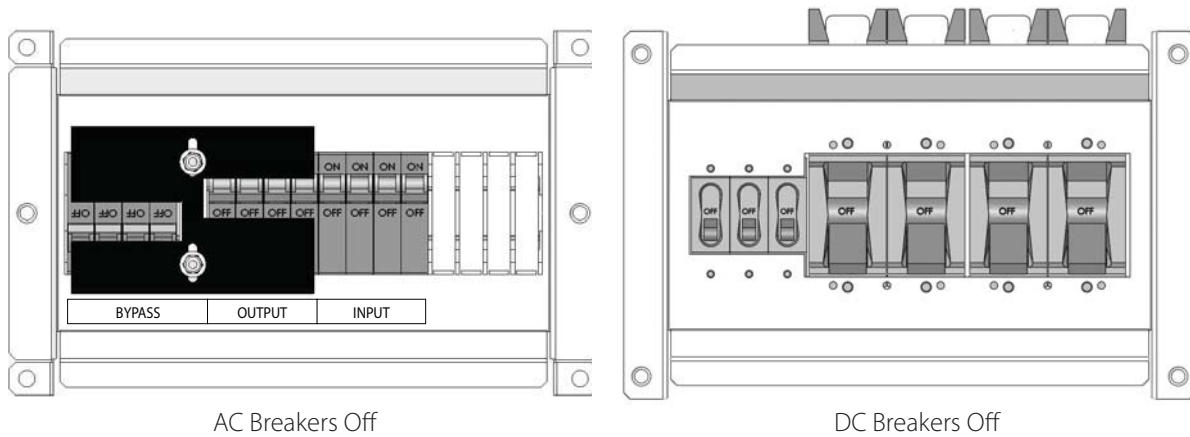

- Connect the OutBack MATE after all other components, including any OutBack Charge Controllers, have been connected and powered up.
- Components installed after powering up the system will require repolling the MATE (please see page 22).
- With the MATE, a user assigns a status and stacking value to the FX on each Port. These status and value assignments can be changed at any time as long as the Master FX is plugged into HUB Port 01.

- "1-2ph Master" for one and two-phase systems
- "3ph Master" for a 3-phase system
- The Master FX is always considered to be the leg one phase.
- GTFX and GVFX models show "Master" not "1-2ph Master" on the MATE screen.

NOTE: Pay attention to the Port number on the screen! Be sure the FX whose status and stacking value you're changing is the one you mean to change.

2. With the FXs connected to the HUB, turn only the DC breakers ON and power up the components. All AC breakers should be OFF.

NOTE: For 3-phase stacking, the jumper in the HUB must be set to the 3ph position. See the *HUB Communications Manager User Guide* for further information.

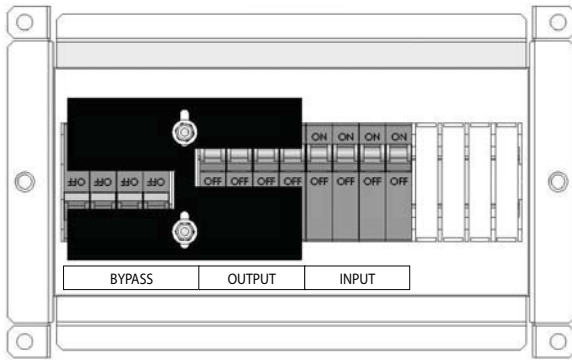

AC Breakers Off

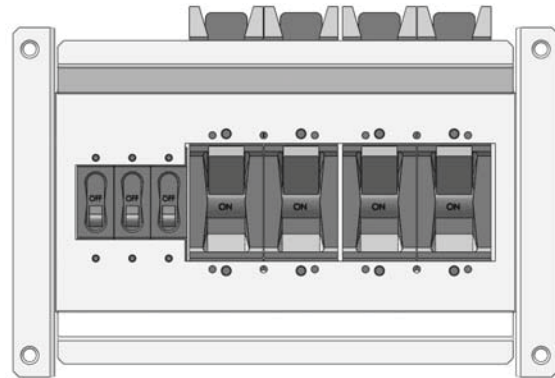

DC Breakers On

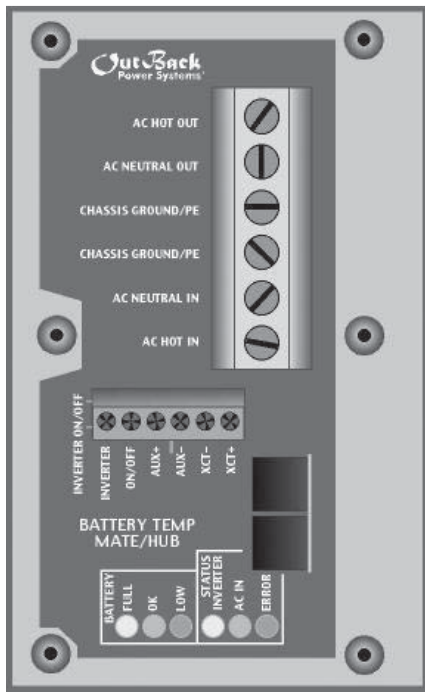

LED Color	LED Action	LED Indicates
Green	Solid GREEN →	Inverter ON
	Flashing GREEN →	Search Mode/Slave Power
	Off →	Inverter OFF
Yellow	Solid YELLOW →	AC Source is Connected
	Flashing YELLOW →	AC Input Live-Waiting to Connect to the FX
	Off →	No AC Input Present
Red	Solid RED →	Error-Error Message, displays on the MATE
	Flashing RED →	Warning: Non-critical FX fault, the MATE can access this information

NOTE: Powering up the FXs can cause the red ERROR STATUS light to blink. After 5-10 seconds, the green INVERTER light should be bright and the ERROR and AC IN lights dark. The FX is now producing AC output voltage.

3. After powering up the components, connect the MATE to the HUB.



- a) Plug the MATE into the 1st MATE Port on the HUB.
- b) The MATE will power up and should recognize any component connected to the HUB.
- c) The MATE can then program the FXs.
- d) The fifth MATE screen ("Port Assignment") should display all the FXs and any OutBack Charge Controllers in the system.

MATE Screens

PATH	→	→	→	→
G'day	(C) 2004 OutBack Power Systems	Version Code a.aa Serial #xxxxxxx Screen EE b.bb	Searching for Devices HUB Found	Port Assignment 1> FX 2> FX 3> CC 4> CC 5> 6> 7> 8> 9> 10> 2M>

4. To verify the MATE recognizes each HUB connected FX and OutBack Charge Controller, disconnect and then either (a) reconnect the MATE to view its boot-up and repoll sequence or (b) follow this path to manually repoll:

PATH	→	→	→	
MAIN----- 12.15:30p	SETUP----- choose device:	SETUP/MATE/PAGE1 mate code rev: 402 choose category:	SETUP/MATE/PAGE2 choose category:	SETUP/MATE/COMM choose produce:
SUM STATUS SETUP ADV	FX MATE	CLOCK CNT GLOW PG2	PG1 SUMRY COMM MAIN	BACK RE POLL PC DEBUG



The FXs are now ready to be programmed according to the stacking options described in the next section.

STACKING OPTIONS

OutBack FXs can be stacked in one of five different configurations:

1. OutBack Parallel
2. Classic Series
3. OutBack Series
4. OutBack Series/Parallel
5. 3-Phase

Note: Although stacking 10 FXs is possible, OutBack's AC hardware only accommodates configurations of two, four, or eight FXs. A system with eight FXs would require two AC Input/Output Bypass (IOB) Assembly Kits or installing an external manual bypass; ten FXs would require three IOB kits or an external manual bypass.

1. Outback Parallel

- 2-10 FXs are wired to the same 120VAC output leg or phase.
- The Slave FXs can be programmed to remain at different power levels ("Silent" or "On" depending on the need) to save energy; the Slaves will come on when the power demand requires them.
- This power-saving system is fully automatic and works with or without a MATE connected to the system, although a MATE is required to program the components. Without a MATE, the user cannot reprogram.
- The AC input (generator or grid) must be 120VAC.



2. Classic Series

- Two FXs are wired to two 120VAC output legs producing 240VAC between them.
- Each FX powers one leg and acts independently of the other, but both combine when 240VAC is required for a load.
- The AC input (generator or grid) must be 240 split-phase VAC.

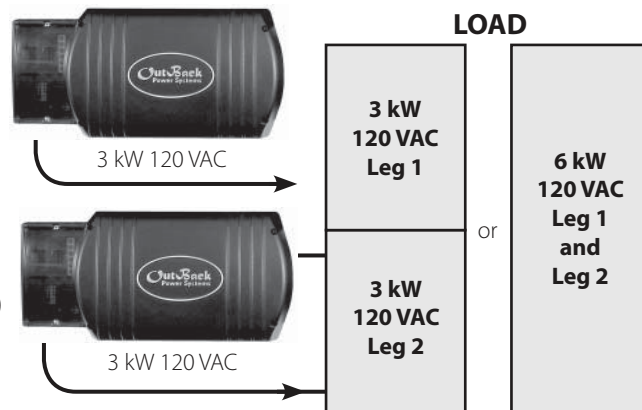

3. OutBack Series

- 2-10 FXs are wired to two 120VAC output legs producing 240 VAC between them.
- This system requires an FW-X240 or PSX-240 Auto Transformer.
- 240VAC can be produced on one leg if the load is ten amps or less; an FX on one leg can power loads on the other leg, helping to balance loads.
- The AC input source (generator or grid) must be 240VAC between both legs.

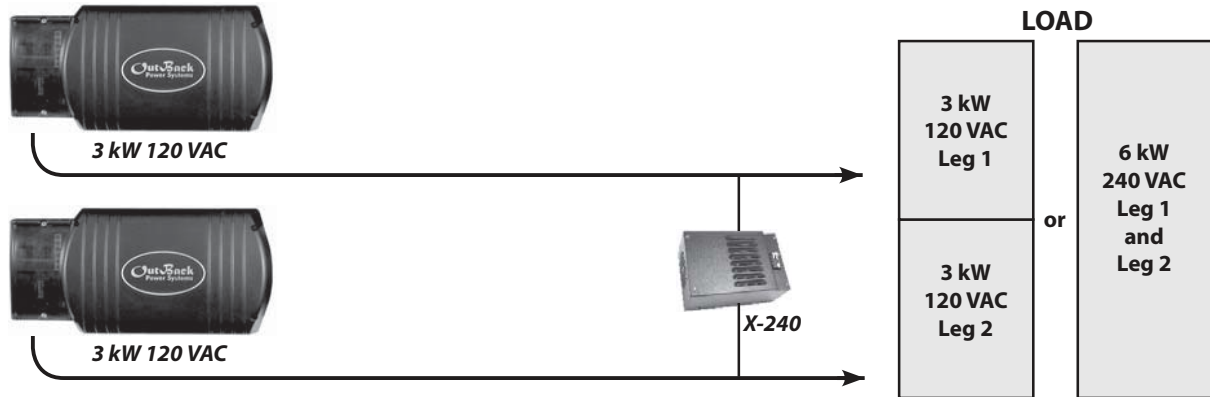

4. OutBack Series/Parallel

- Unique to OutBack, the loads are balanced between two 120VAC legs, changing between series and parallel as needed.
- An FW-X240 or PSX-240 Auto Transformer is required to balance the loads.
- This system allows for larger AC loads without overloading either of the FX 120 VAC outputs; it also allows for 240 split-phase using only one FX.

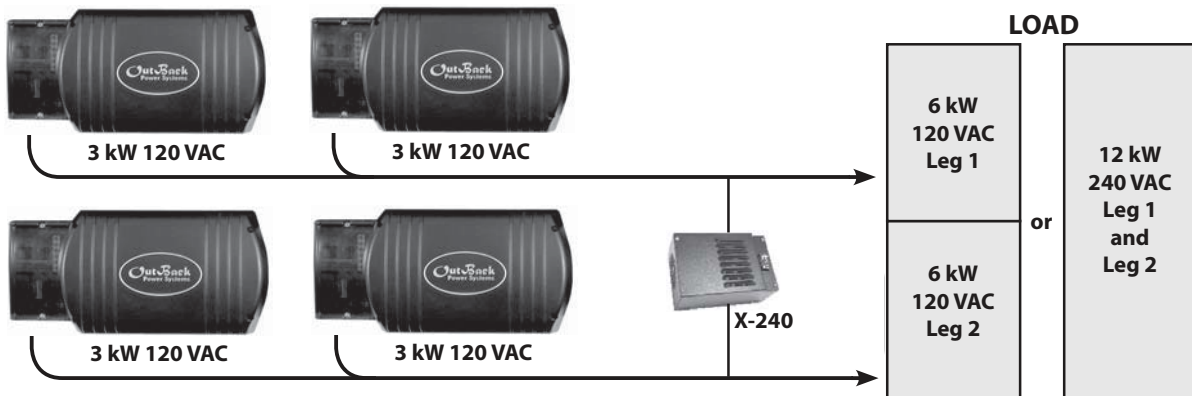

5. 3-Phase

- Three—and only three— FXs are connected, one to each of three 120 VAC output legs that produce 208 VAC between any two legs of the system.
- The HUB requires a jumper between the two Slave FXs for this stacking to function (see HUB Manual).
- The AC input source (generator or grid) must be a 120 VAC/208VAC 3-phase source.

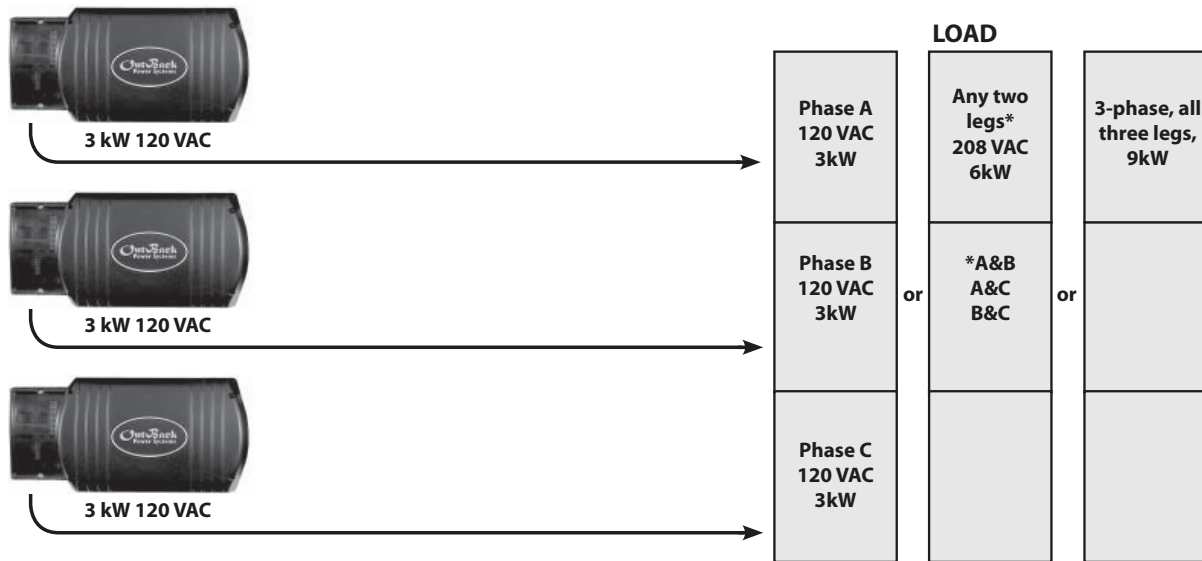

Stacking and Assigning FX Status

Use the MATE to establish the order or hierarchy of all the system FXs by designating each as one of the following:

- 1-2ph Master (OutBack Parallel, OutBack Series, or Classic Series stacking)
- Classic Slave (Classic Series stacking)
- OB (OutBack) Slave L1 (OutBack Parallel, OutBack Series, or OutBack Series/Parallel stacking)
- OB (OutBack) Slave L2 (OutBack Parallel, OutBack Series, or OutBack Series/Parallel stacking)
- 3ph Master (3-Phase stacking)
- 3ph Slave (3-Phase stacking)

1. 1-2ph Master

- This is the default ranking of every FX. It applies to one-phase and two-phase systems.
- One Master FX is established for every multiple FX system.

2. Classic Slave

- Classic Slave is the designation of the second FX in a two-inverter, split-phase system that produces 240 VAC without using an FW-X240 Auto Transformer.
- This FX is plugged into Port 02 of the HUB.

OB Slave L1 and OB Slave L2 designations are used in OutBack Parallel Stacking or OutBack Series/Parallel stacking

3. OB Slave L1

- In an OutBack Parallel single-phase system, all the Slave FXs on a single 120 VAC leg are designated OB Slave L1.
- In an OutBack Series split-phase system, which will include an FW-X240 or PSX-240 Auto Transformer, any FX that runs in parallel to the Master FX is designated OB Slave L1. These FXs must be plugged into the lowest HUB Ports.
- The OB Slave L1 Stacking is typically used for an entirely off-grid application such as a cabin that does not require 240 volts.

4. OB Slave L2

- In an OutBack Series split-phase system, any Slave FX that runs in series with the Master FX is designated OB Slave L2.

5. 3ph Master

- In 3-phase stacking, the Master FX is designated as 3ph Master.

3ph Master and 3ph Slave designation are used in OutBack 3-phase stacking.

6. 3ph Slave

- In 3-phase stacking, each of the Slave FXs, which should be plugged into HUB Ports 02 (phase B) and 03 (phase C) respectively, is designated as 3ph Slave.
- When the HUB jumper is set between Port 02 and Port 03, the HUB identifies a phase for each Slave FX.

Stacking Phases/Assigning FX Status (in order):

1. 1-2ph Master*
2. Classic Slave
3. OB Slave L1
4. OB Slave L-2
5. 3ph Master
6. 3ph Slave

*GTVX and GVFX models show "Master" on the screen

PROGRAMMING THE FXs

Once the MATE recognizes each FX (and Charge Controller or CC), push and hold the first two soft keys simultaneously to return to the MAIN menu. To program the FXs, go to the ADV/FX/STACK menu on the MATE navigating with the following steps:

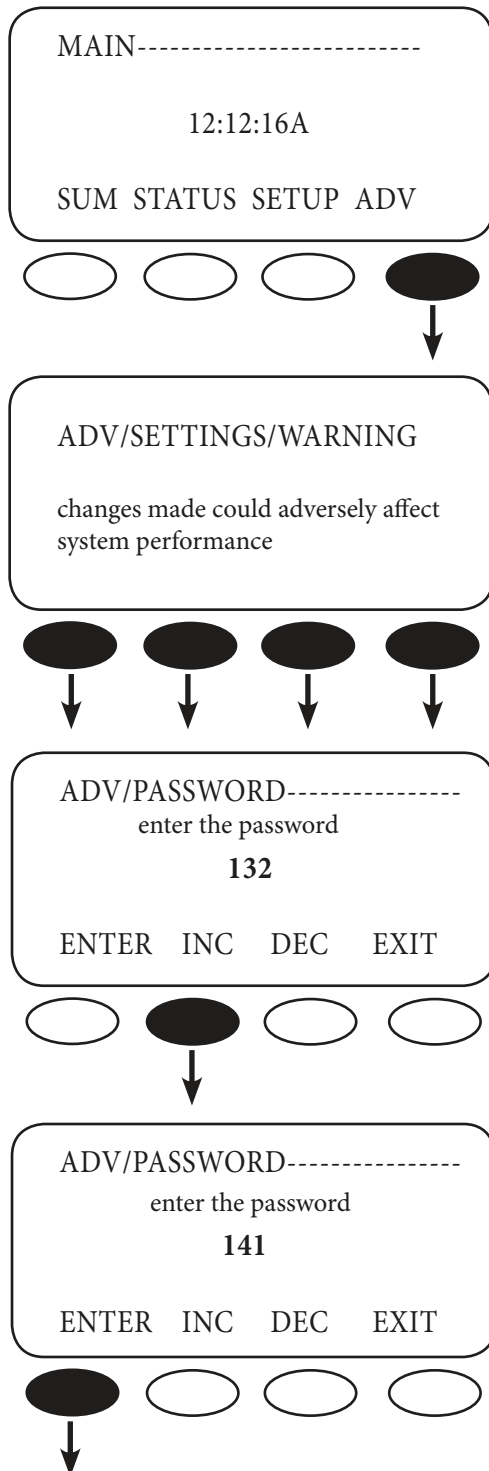

Press **ADV**.

NOTE: Pressing and holding the first two soft keys at the same time will always bring up the Main Menu screen.

Push any soft key on the ADV/SETTINGS/WARNING screen and go to the ADV/PASSWORD screen.

The screen displays 132. Press **INC** until it scrolls to the password 141.

Push **ENTER**.

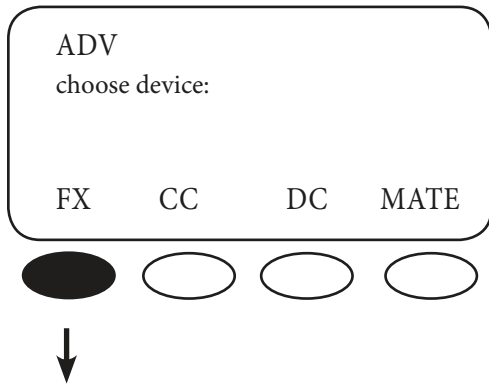

In the ADV menu, press **FX**.

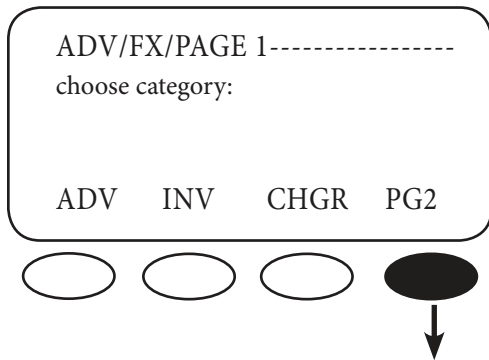

On the ADV/FX/PAGE 1 screen, press **PG2** and go to the ADV/FX/PAGE2 screen.

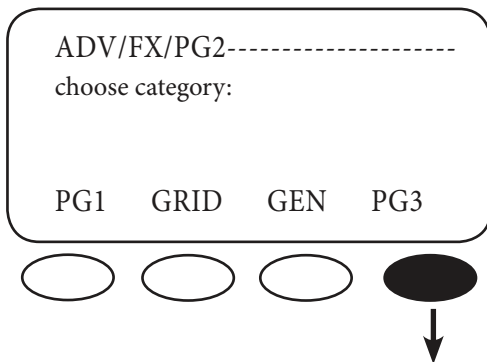

Press **PG3** which leads to the ADV/FX/PAGE3 screen.

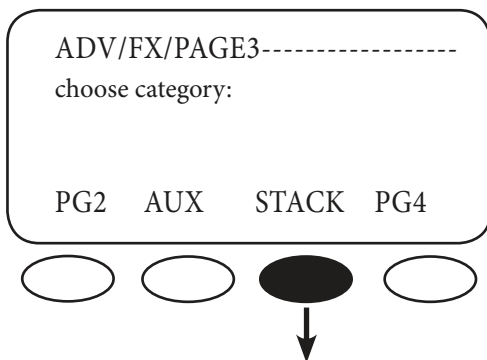

On the ADV/FX/PAGE3 screen, press **STACK**.

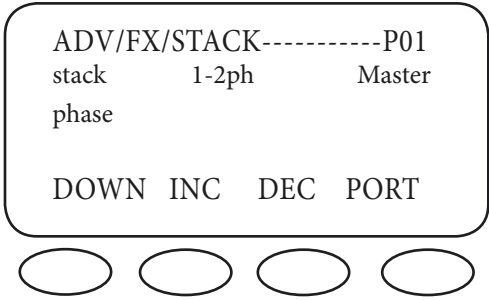

Stacking the FX Series Inverter/Chargers begins on this screen. See specific stacking procedures in the next section.

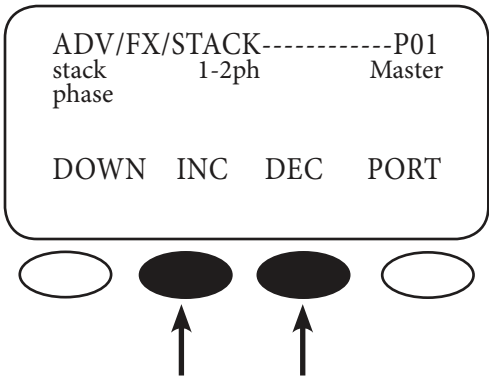

Port 01 always takes the Master FX.

Pressing **PORT** changes the HUB Port whose value you wish to adjust.

• Pressing **INC** or **DEC** changes the stacking phase.

1-2ph Master

With the Port 01 FX as the Master, press the **<PORT>** soft key to change the remaining Ports and designate the remaining FXs as Slaves. The MATE screen for Port 02 will look like this:

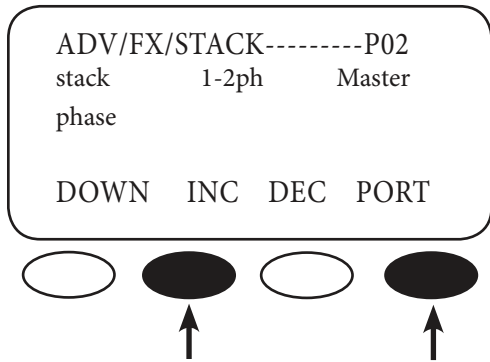

← The MATE is now ready to program the FX plugged into Port 2 of the HUB.

1-2ph Master is the factory default value for each FX.

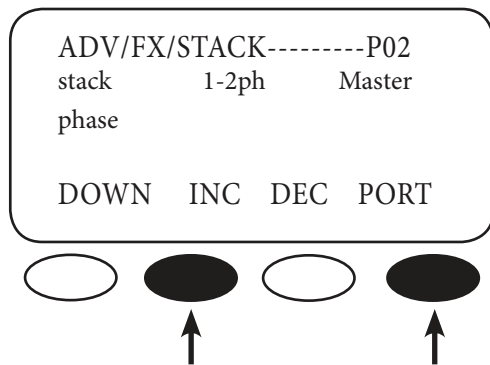

Pressing **INC** will keep the MATE's attention on Port 2, but will change the stack phase to Classic Slave screen. Port 02 will then be assigned as a Classic Slave. You can change the stacking phase by pressing **INC** or **DEC** and change to a different Port by continuously pushing **PORT**.

NOTE: There are no **<OK>** or **<DONE>** commands in the stacking menu. Whichever value—Master or Slave—shows up on the MATE screen will be assigned to the chosen Port (and FX) upon leaving that screen. It's important to watch the Port number in the top right corner of each screen to be sure you've assigned it the desired status.

OutBack (OB) Slave

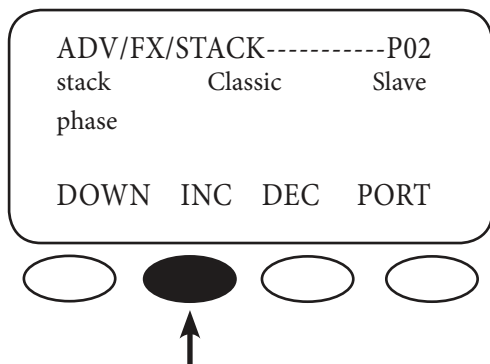

Systems with two to ten FXs call for OutBack Slave Stacking. Press **INC** in the ADV/FX/STACK screen to change the stack phase from Classic Slave to OB Slave L1.

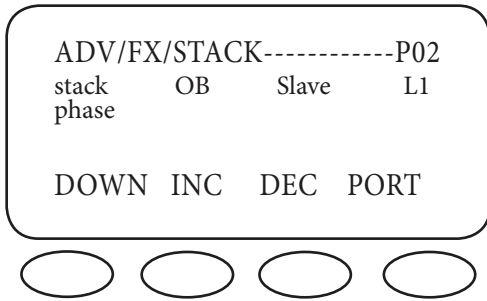

OB Slave 1 stacking phase

OutBack (OB) SLAVE L2

- Set the FX's you want as series Slaves (Leg 2) to OB Slave L2.
- This FX is considered the L2 phase.

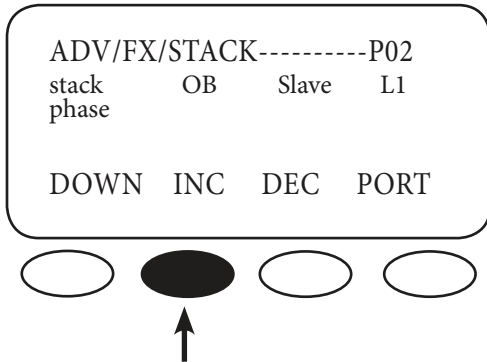

To use OutBack Slave L2 stacking, press **INC** in the ADV/FX/STACK OB screen to change the stack phase from OB Slave L1 to OB Slave L2.

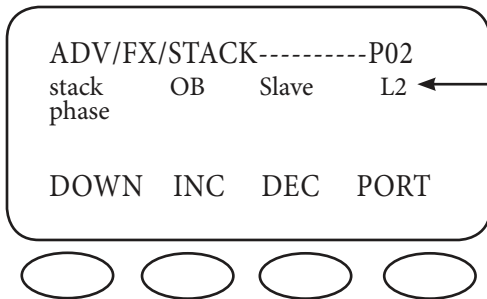

The FX assigned to Port 02 now has OB Slave L2 status.

3-Phase (3ph) Master

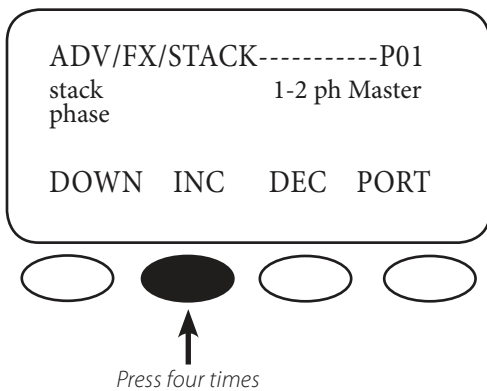

A 3-phase system with only three FXs requires one of two different stacking procedures. Starting from the first stacking menu—ADV/FX/STACK—press **INC** four times.

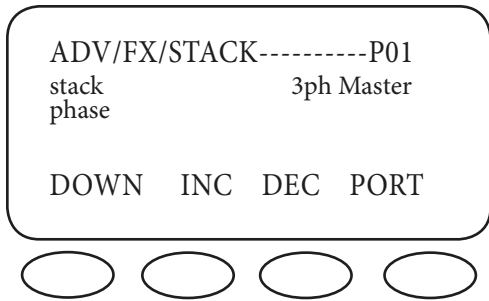

The FX has now been set to 3ph Master status.

3-Phase (3-ph) Slave

- Set the two Slave FX's to 3ph Slave and make sure they are in Ports 02 and 03 of the HUB.
- There are no selections to differentiate between phases B and C.
- When you set the jumper in the HUB for 3-phase, the HUB assigns each Slave to its phase. 3ph Slave on HUB Port 2 is considered phase B.
- 3ph Slave on HUB Port 3 is considered phase C.

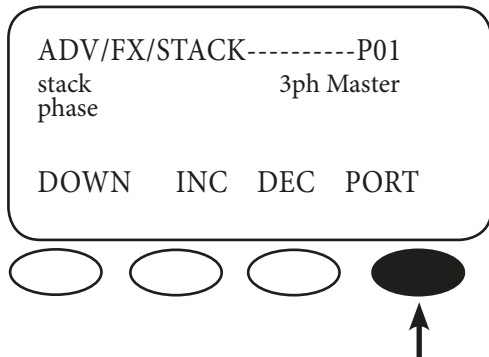

From the 3ph Master screen, press **PORT** until P02 appears.

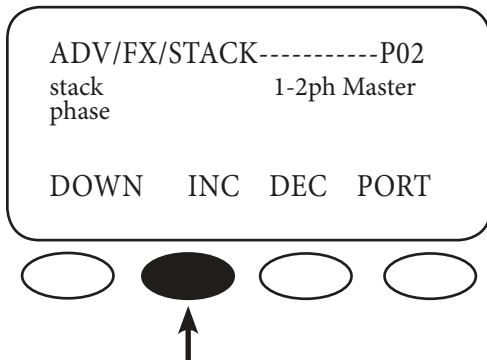

Each new Port screen in the stacking menu will open with *1-2ph Master* displayed. To change the stacking designation, press **INC** until *3ph Slave* appears.

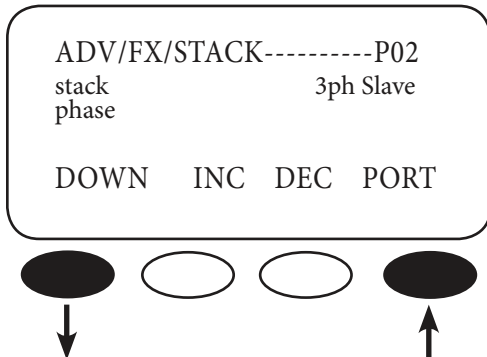

After establishing P02 as a *3ph Slave*, move onto P03 and repeat the procedure. Press **DOWN** when finished.

Introduction to Power Save Levels

Depending on the model, each FX consumes 20-25 watts of power when it remains on, even if it isn't actively inverting or charging. OutBack Power Systems offers the option to shut down (put into Silent mode) some or all of the Slave FXs until the loads require them to come on again.

- When a load exceeds 12 amps AC, the Master FX shares the load with one or more Slave FXs.
- When the Master detects only a four amp load, a Slave FX goes into Silent mode; Slaves will continue to go into Silent mode as long as the Master detects four amps.

The next two screens in the MATE's Stack menu adjust the power levels of the Master and Slave FXs. From any STACK PHASE screen:

- Press **DOWN** once to bring up the *power save level master adjust only* screen
- Press **DOWN** again to bring up the *power save level slave adjust only* screen

NOTE: These *power save level master adjust only* and *power save level slave adjust only* screens pertain to systems that have OB Slave L1 and/or OB Slave L2 type Slaves only.

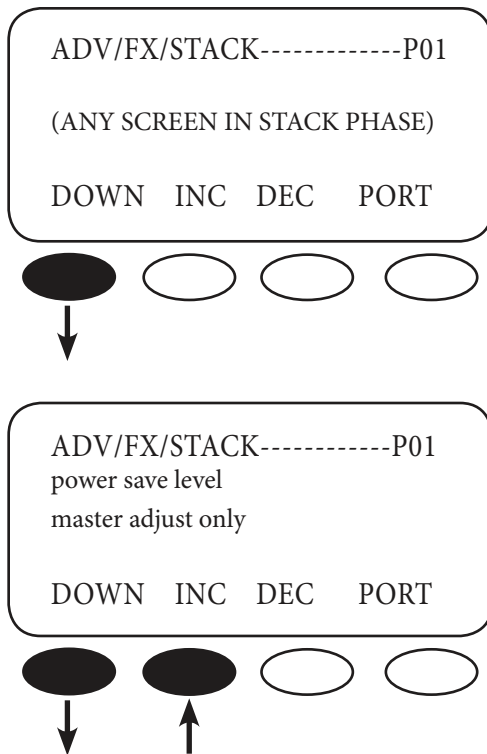

Press the **DOWN** soft key once.

Press **INC** to increase the power save level master adjust only value. Any Slave with this value or lower which is assigned in the *power save level slave adjust only* screen (next), will be on with the Master. If the *power save level master adjust only* is three, for instance, any Slave assigned a value of 3 or lower will be on when the Master is on. Since the Master is essentially always ON, these Slaves will always be on as well. Any Slave with a value of 4 and higher will be Silent until the Master activates them for larger loads. For days of the week with small load demands, a user can decrease the *power save level master adjust only* value so fewer FXs are running.

The default value is zero (only the Master is on).

Press **DOWN** to view the *power save level slave adjust only* screen.

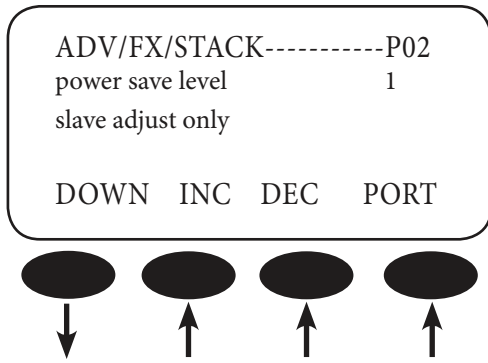

The default value for the *power save level slave adjust only* screen is 1. Press **INC** or **DEC** to adjust this value. Press **PORT** to change the value of each Slave FX.

The Slave(s) must be connected to Port 2 or higher on the HUB.

With the Master FX default value of zero in the *power save level master adjust only* screen, all of the Slave FX's will remain OFF until the Master FX needs help and calls for the Slave FX's with a Slave ranking equal to 1 to come ON.

Choose a different Slave ranking for each Slave FX. This helps assure proper operation and allows them to come ON one at a time saving power in the long run. Otherwise, with a default value of 1 for all Slaves, they will all come on whenever a 12 amp load calls for more power, but then can quickly shut off because multiple FXs provide far more than the required 12 amps. Ranking them 1, 2, 3, 4 etc. means they will come on one at a time as needed to better serve the loads and conserve energy.

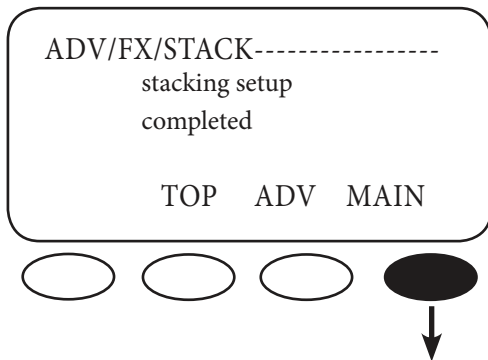

Press **DOWN** to view the final stacking screen.

Press **MAIN** to return to the Main Menu.

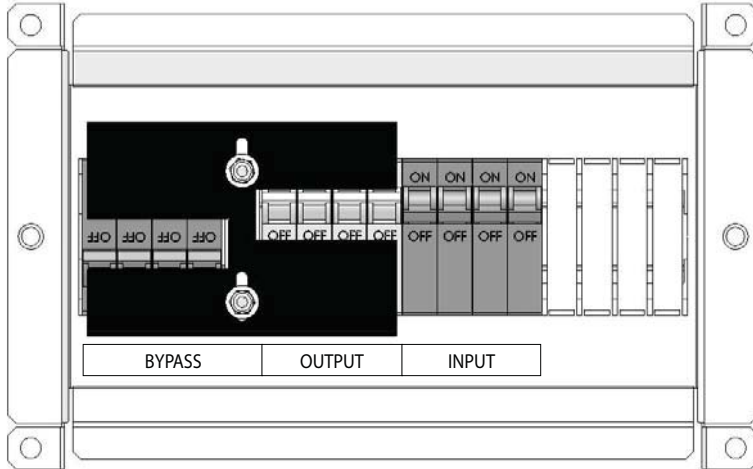

With the programming completed, turn the AC output breakers ON with the AC BYPASS on the AC breaker panel switched to NORMAL.

NOTE: If you are doing OutBack Stacking, turn on the FW-X240 Auto Transformer breaker now. Otherwise, go to the next step.

- Verify the AC voltage output through the MATE following path:

PATH	→	→	→	
MAIN----- 12.15:30p	STATUS----- choose device:	STATUS/FX/PAGE1----- choose category:	Float P00 inv 0.0Kw zer 0.0kw chg 0.0kw buy 0.0kw	STATUS/FX/METER—P00 output 117 vac voltage
SUM STATUS SETUP ADV	FX CC DC MAIN	MODES METER BATT PG2	DOWN STATUS PORT	DOWN UP TOP PORT



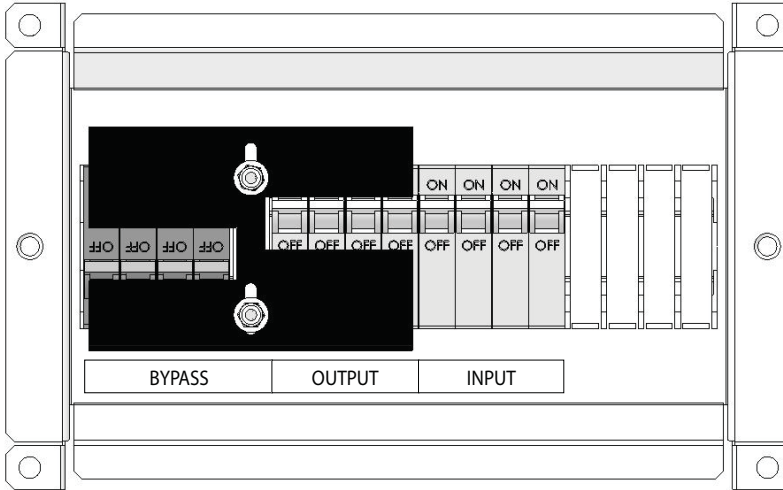

Turn the AC input breakers ON.

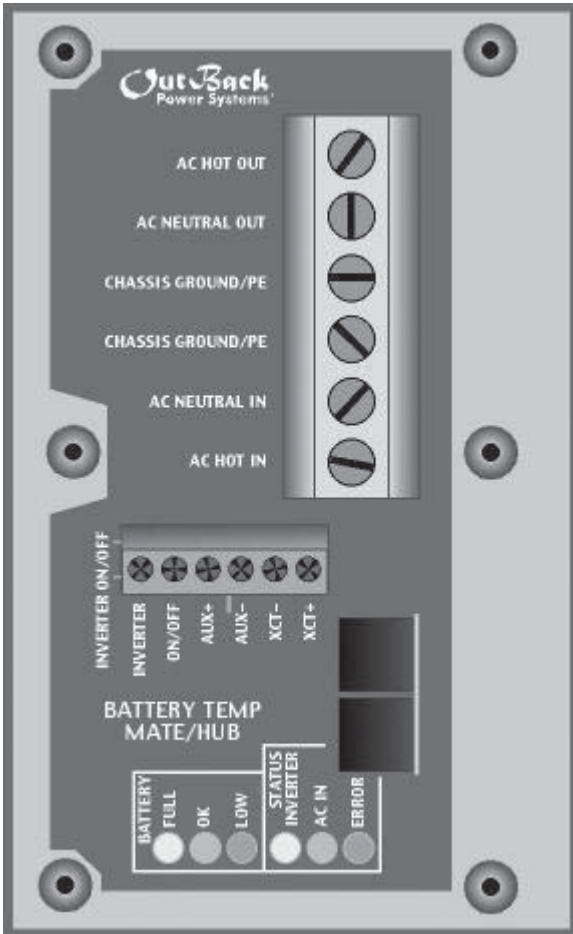

If the FX's AC source is available, the yellow AC IN STATUS light will blink. The FX will connect to the utility grid when the voltage is within 108-140VAC and the frequency between 54-66 Hz. After about 30 seconds, the AC IN light should stop blinking and stay lit. The FX will now perform a battery charge using the available AC.

Stacking System Examples

Dual-Stacked System Using Classic Stacking

- The system includes only two FXs and must be set up as described here.
- The bottom FX Series Inverter/Charger is plugged into Port 01 of the HUB and the next or second FX is plugged into Port 02.
- Turn off all AC Output and AC Input breakers before powering up the FXs.

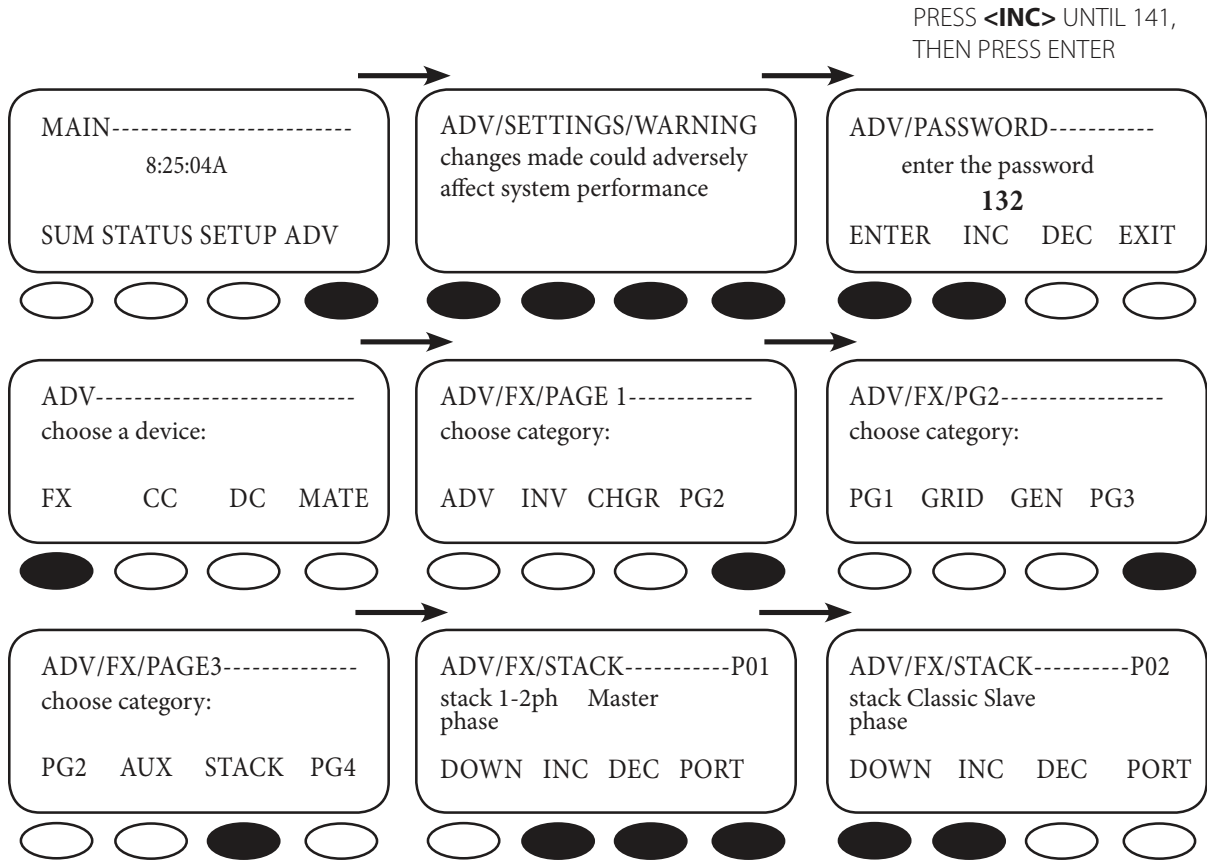

1. Press the **<INC>** or **<DEC>** soft keys until the "stack 1-2ph master phase" screen appears.
2. Press the **<PORT>** soft key until P02 is displayed.
3. Push the **<INC>** soft key once to set to *Classic Slave*. This establishes the Slave 1 FX at Port 2 to be in series with the Master at Port 1.
4. Press the **<DOWN>** soft key three times to return to the MAIN screen.

OutBack Parallel Stacking

- Four FXs in a single system are referred to as a Quad Stack.
- The FX installed at the bottom of the stack is plugged into Port 1 of the HUB.
- The second, third, and fourth FXs are plugged into Ports 2, 3, and 4 respectively.

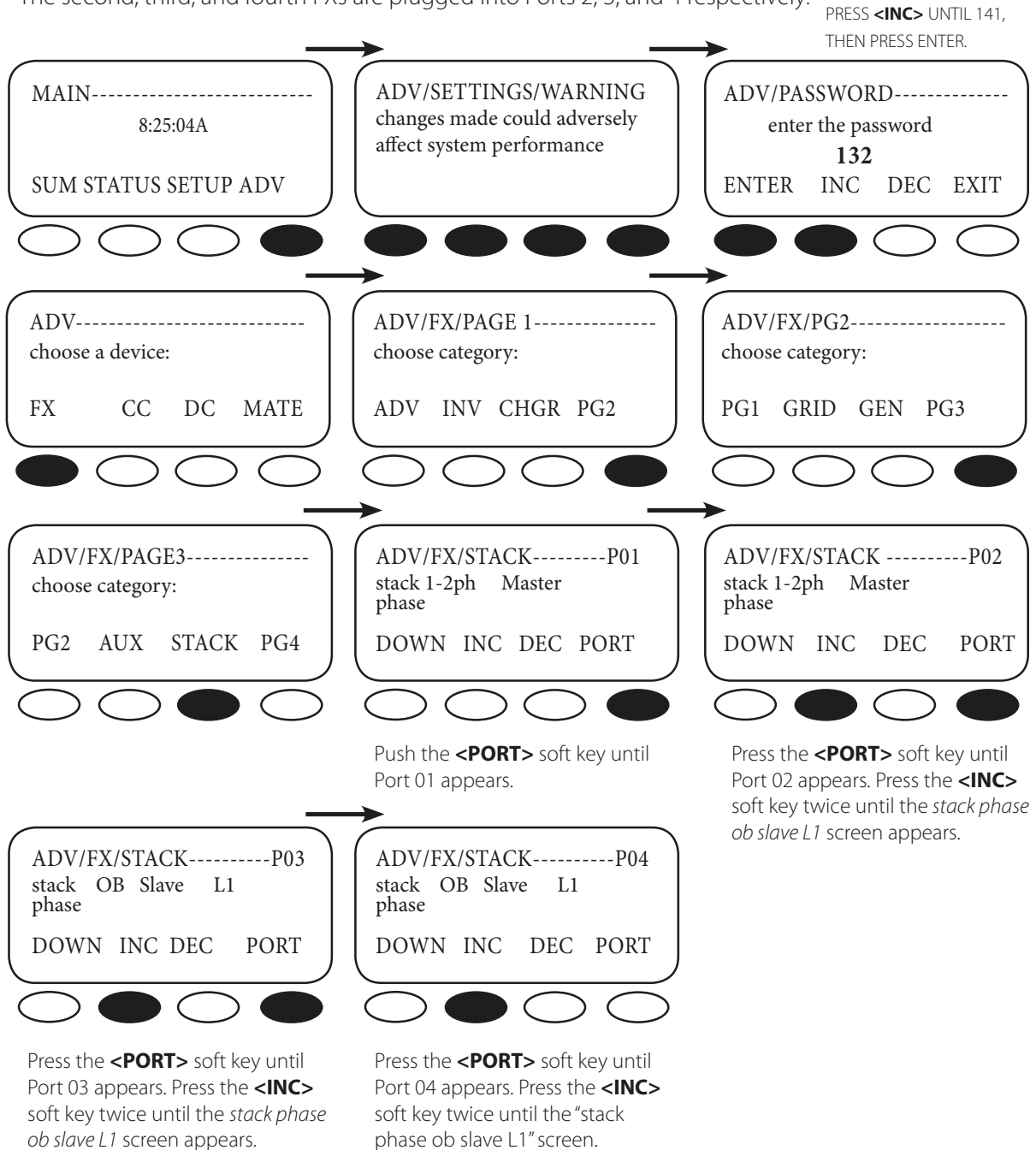

At completion, each Slave FX in Ports 2, 3, and 4 will be in parallel with the Master in Port 01. Additional Slaves can also be programmed as *OB Slave L1* following the instructions above. All the Slave FXs connected to Ports 2, 3, and 4 are now in parallel with the Master in Port 01. Remain in this screen. The next step is to rank the Slaves in relation to the Master.

Ranking the Slaves

- Start from the last ADV/FX/STACK screen.

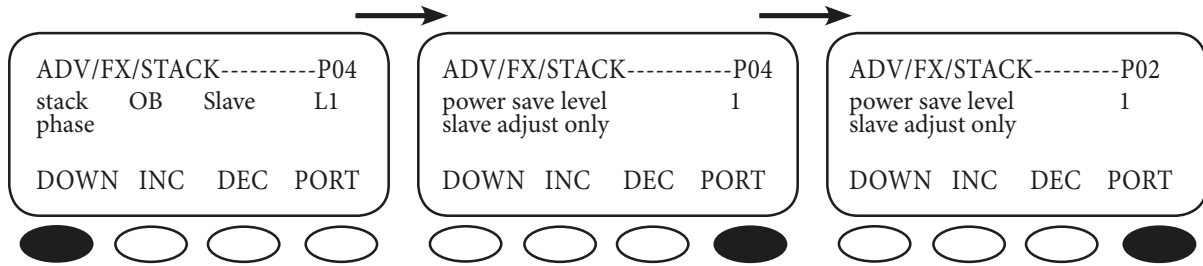

Press the **<DOWN>** soft key 2 times to the *power save level slave adjust only* menu.

Press the **<PORT>** soft key until P02 is displayed. This menu pertains to the Slaves only. The default setting should be 1 which is the 1st rank Slave. If necessary, press the **<INC>** or **<DEC>** soft keys to make it 1.

Press the **<PORT>** soft key until P03 is displayed.

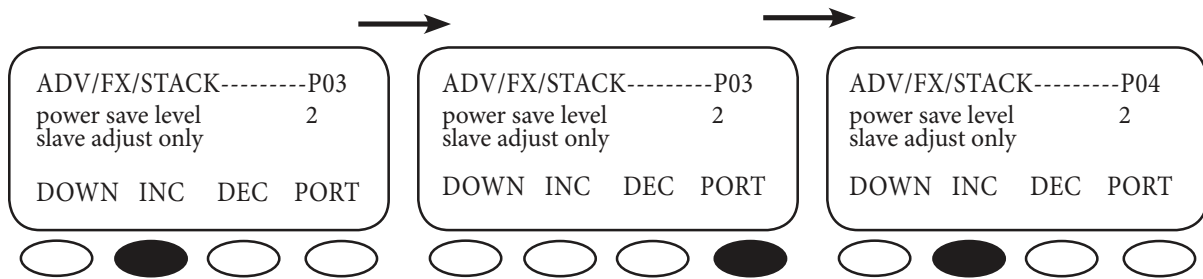

Press the **<INC>** soft key to change the *power save level Slave adjust only* to 2 which is the 2nd rank slave.

Press the **<PORT>** soft key until P04 is displayed.

Press the **<INC>** soft key until the setting is 3 for 3rd rank Slave.

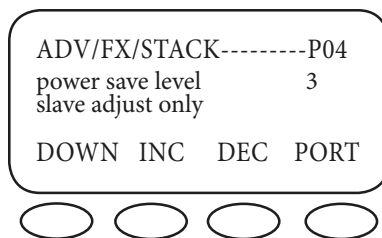

The Slaves are now ranked. Any remaining Slaves can be ranked in the same fashion. When finished ranking the Slaves, remain in this screen for the next procedure

After setting up your OutBack Parallel Stacking and establishing the Master and Slave order, shut off all the AC input and output breakers and check your system via the following MATE screens:

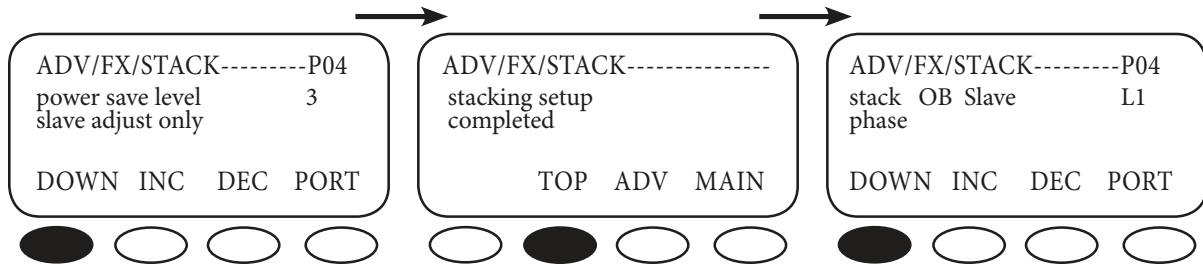

From the ADV/FX/STACK *power save level slave adjust only* screen, press the **<DOWN>** soft key, the **<TOP>** soft key, and then the **<DOWN>** soft key.

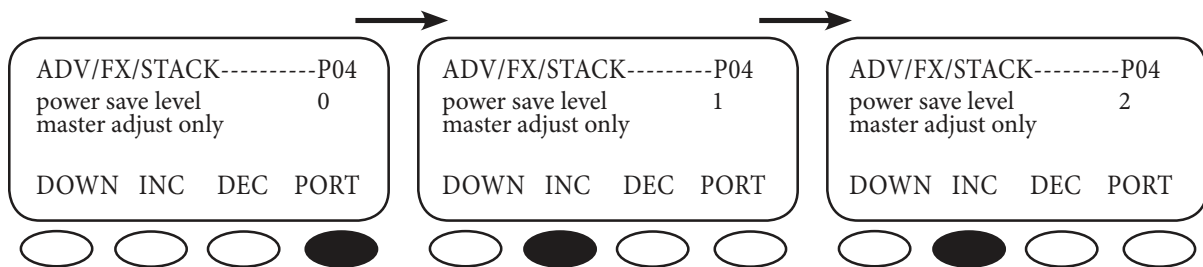

Verify this is the power save level master adjust only screen. Press the **<PORT>** soft key until P01 appears on the screen. Turn on all of your FX AC Output breakers. The Master FX's "INVERTER" LED should be solid and all the Slaves "INVERTER" LED's should be blinking.

Press the **<INC>** soft key to adjust the "power save level master adjust only" from 0 to 1 and watch the 1st Slave's "INVERTER" LED go solid. When the "INVERTER" LED is on solid, this means that the inverter is on. When the "INVERTER" LED on the Slave is blinking, this means the FX is asleep.

Press the **<INC>** soft key once to adjust the power save level master adjust only to 2 and watch the 2nd Slave's "INVERTER" LED turn on

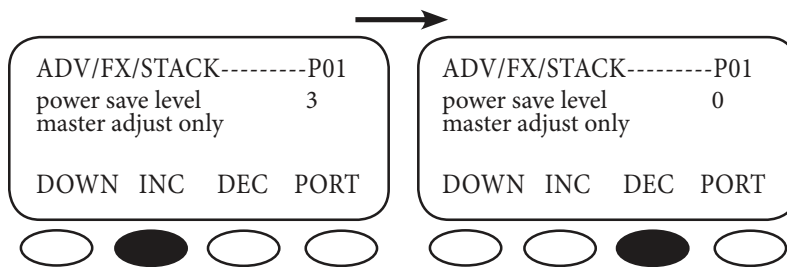

Press the **<INC>** soft key once to adjust the power save level master adjust only to 3 and watch the 3rd Slave's "INVERTER" LED turn on. If the system has more than three Slaves, keep increasing the value in the *power save level master adjust only* screen and verify that each Slave's "INVERTER" LED comes on as expected. This check verifies all FXs are stacked correctly.

Adjust the power save level master adjust only to 0 by pressing the **<DEC>** soft key.

OutBack Series / Parallel Stacking

OutBack Series/Parallel Stacking is a versatile configuration for a system using between two and ten FXs with AC outputs connected to one of the two 120 VAC legs. Although it's acceptable to divide the FXs unevenly between the two 120 VAC legs, at least one FX must be on each leg. This example:

- Uses a quad-stacked system with two FXs on each leg
- Sets an FX as *OB Slave L1* indicating that it is in parallel (on the same Leg) with the Master FX
- Sets an FX as *OB Slave L2* indicating that it is in series (on the opposite Leg) with the Master FX
- Has the lower-installed FX plugged into Port 01 of the HUB

The second FX up is plugged into Port 02, the third FX down is plugged into Port 03, and the fourth FX down is plugged into Port 04.

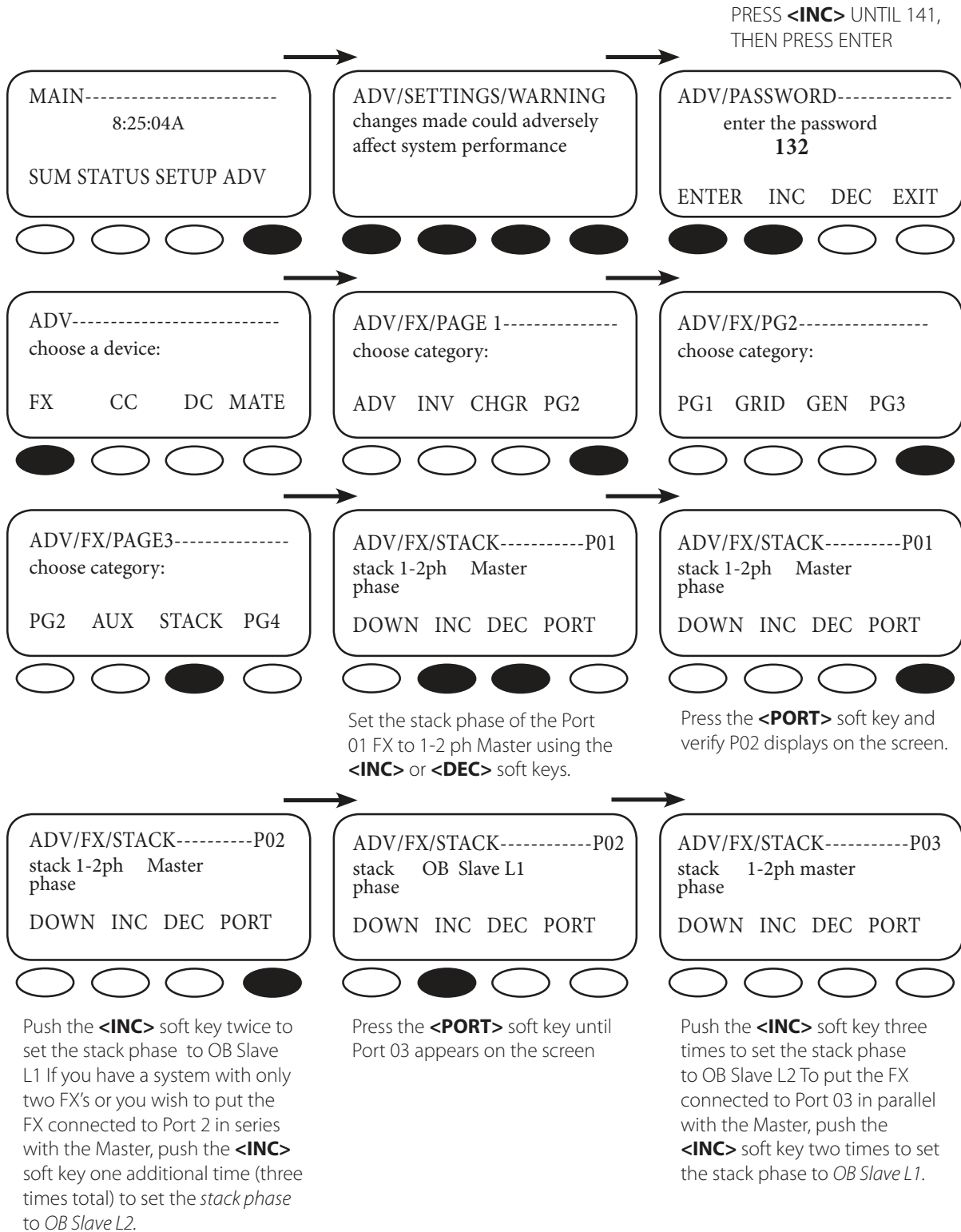

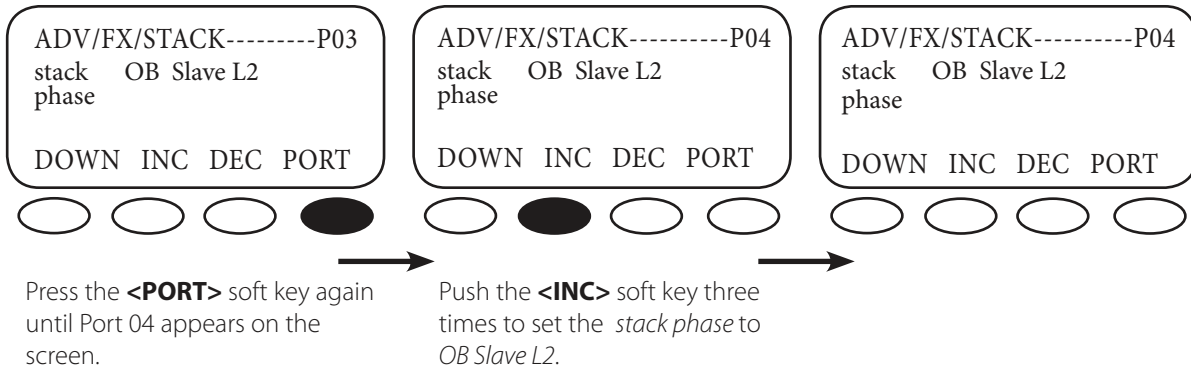

NOTE: Any additional FXs in the system can be programmed by pressing the **<PORT>** soft key to get to the next FX and then press **<INC>** twice (*OB Slave L1*) for parallel stacking or three times for series stacking. In this example, one FX (P02) is set to be in parallel with the Master (P01) and two FXs (P03 & P04) to be in series with the Master.

Ranking the Slaves:

- From the last screen— ADV/FX/STACK P04—press the **<DOWN>** soft key twice to get into the *power save level slave adjust only* menu. This menu allows you to set the order in which the Slave FXs come “ON”
- Press the **<PORT>** soft key until P03 is displayed. The FX on Port 03 is the first Slave that is in series (“OB Slave L2”) with the Master. With this FX as the 1st rank Slave, both Legs turn “ON” directly, producing 240VAC without using the FW-X240. If you have a system that is different from this example then press the **<PORT>** soft key until you get to a Slave FX that is in series (OB Slave L2) with the Master.
- If the screen’s factory setting is not set to 1—the 1st rank Slave—then press the **<DEC>** soft key until it becomes 1. Press the **<PORT>** soft key until P02 appears. If you have a system that is different from this example then press the **<PORT>** soft key until you get to a Slave FX that is in parallel (OB Slave L1) with the Master.
- Press the **<INC>** soft key to change the *power save level slave adjust only* to 2, which is the 2nd rank Slave.
- Press the **<PORT>** soft key twice until Port 04 is displayed. If you have a system that is different from this example then press the **<PORT>** soft key until you get to the next Slave FX that is in series (OB Slave L2) with the Master.
- Press the **<INC>** soft key until the setting is 3 for 3rd rank Slave. Any additional FXs in the system can be programmed by pressing the PORT soft key to get to the next FX and then press **<INC>** until the setting is 4 for the 4th rank Slave. Continue this process, making sure each FX has its own slave ranking, until you have set all FXs.

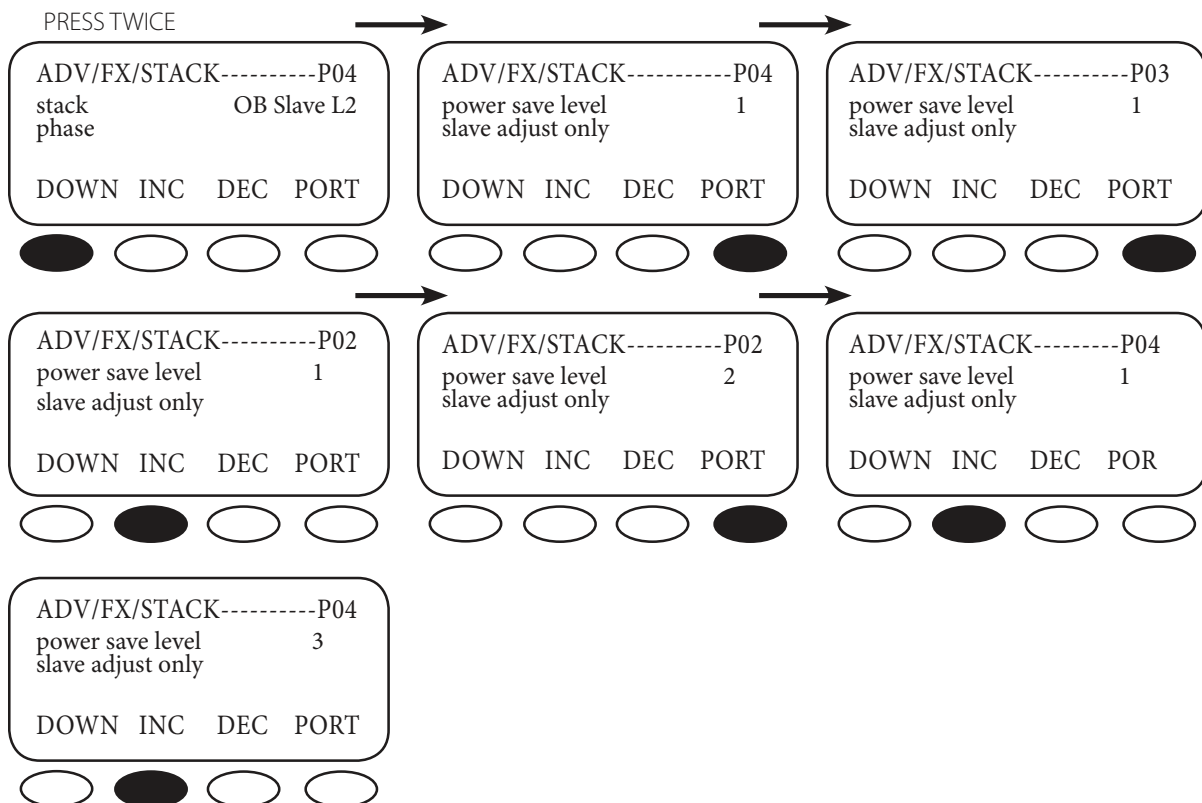

With OutBack Series/Parallel Stacking and the Master and Slave order established, check the system:

- From the ADV/FX/STACK *power save level slave adjust only* screen, press the **<DOWN>** soft key, the **<TOP>** soft key, and then the **<DOWN>** soft key.
- Verify the next screen is the *power save level master adjust only* screen.
- Press the **<PORT>** soft key until P01 appears.
- Turn on all FX output breakers.
- The Master FX's INVERTER LED should be solid and all the Slaves INVERTER LEDs should be blinking.
- Adjust the *power save level master adjust only* from 0 to 1 by pressing the **<INC>** soft key and watch the 1st Slave's INVERTER LED go solid.
- When the INVERTER LED is on solid, the inverter is on. When the INVERTER LED on the Slave is blinking, the FX is asleep.
- Press the **<INC>** soft key once to adjust the *power save level master adjust only* to 2 and watch the 2nd Slave's INVERTER LED turn on.
- Press the **<INC>** soft key once to adjust the *power save level master adjust only* to 3 and watch the 3rd Slave's INVERTER LED turn on.
- If you have more than three Slaves, keep increasing the value in the *power save level master adjust only* screen and verify each Slave's INVERTER LED comes on as expected.
- This check verifies all FX Series Inverter/Chargers are stacked correctly.
- Adjust the *power save level master adjust only* down to 0.

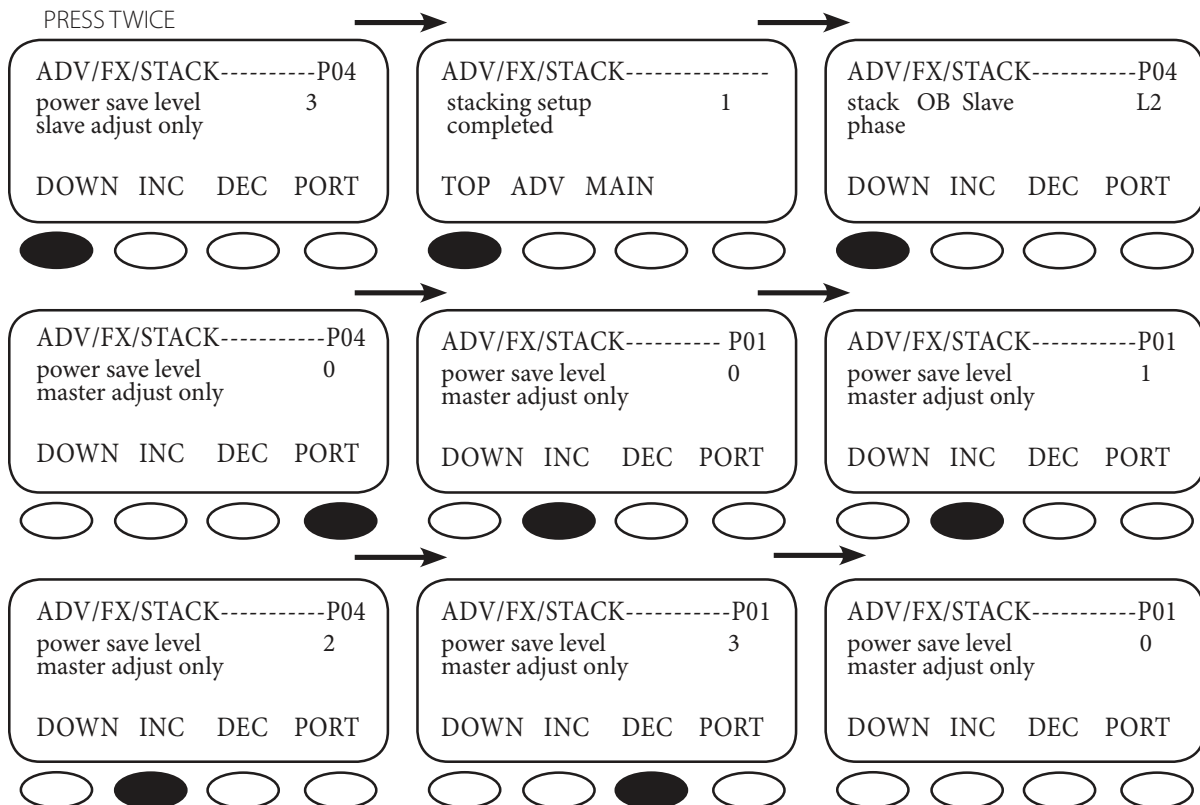

3-Phase Stacking (Three FX Series Inverter/Chargers Only)

A 3-phase stacked system with only three FXs must be set up as described here:

- Turn off all AC output and AC input breakers before powering up FX's.
- Plug the top FX into Port 01 of the HUB, the 2nd FX into Port 02, and the 3rd FX into Port 03.
- Change the HUB jumper for 3-phase stacking (refer to the HUB manual).
- Go to the first MATE stacking menu (*stack phase*) press the **<PORT>** soft key until Port 01 appears.
- Set the *stack phase* of the Port 01 FX to *3ph Master* by pressing the **<INC>** soft key. The Master FX is considered phase A.
- Press the **<PORT>** soft key and verify P02 (2nd FX) displays.
- Press the **<INC>** soft key five times to set the *stack phase* to *3ph Slave*. The P02 FX is now set as phase B, producing 208VAC between itself and the Master (P01).
- Press the **<PORT>** soft key again and verify P03 (3rd FX) is displayed.
- Push the **<INC>** soft key five times to set the *stack phase* to *3ph Slave*. This FX (P03) is now set as phase C, producing 208VAC between itself and the Master (P01) and also 208VAC between itself and the FX on phase B.

NOTE: The AC input to a 3-phase system must be a 3-phase source (generator or grid).

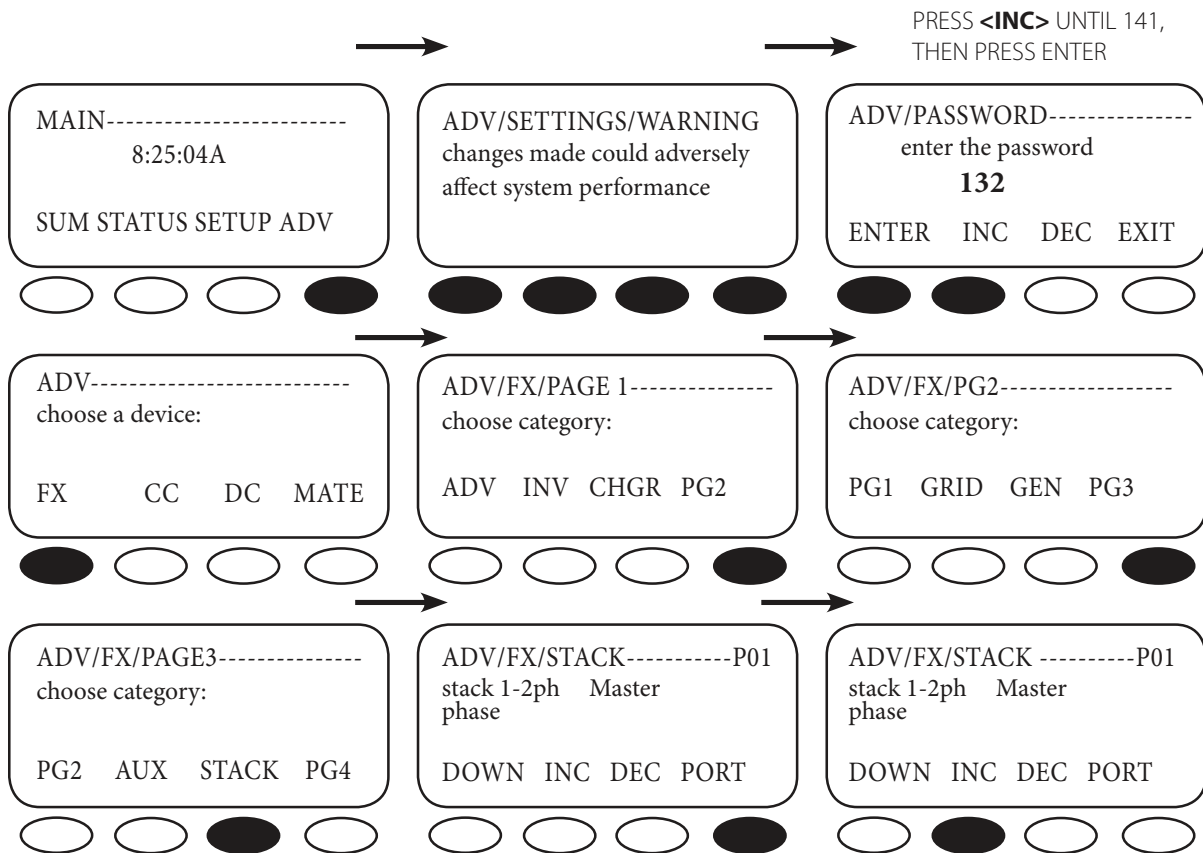

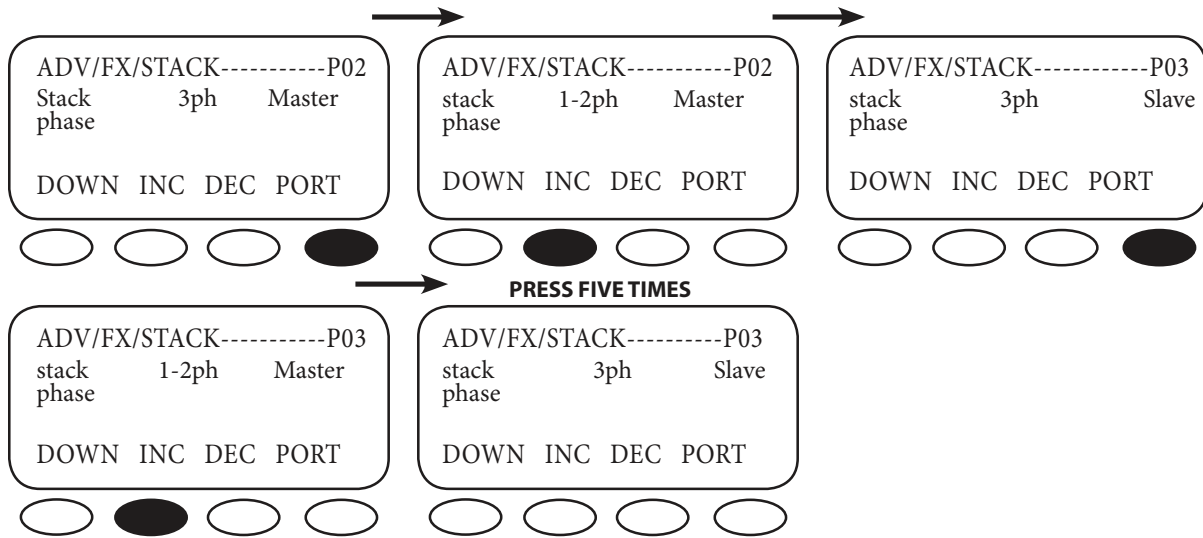

Auxiliary (AUX) Functions

The AUX output provides a 12VDC, 0.7ADC max output at the AUX terminals to control either DC or AC external loads. Typical loads include signaling a generator system to start, sending a fault alarm signal, or running a small fan to cool the FX.

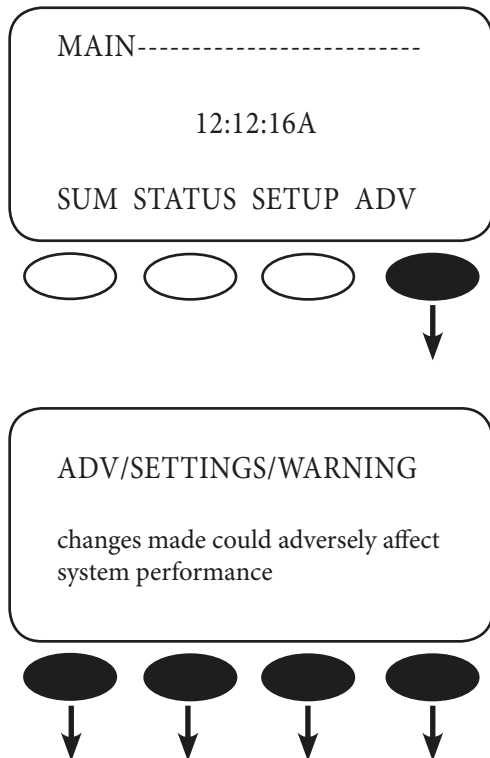

Press **ADV**.

NOTE: Pressing and holding the first two soft keys at the same time will always bring up the Main Menu screen.

Push any soft key on the ADV/SETTINGS/WARNING screen and go to the ADV/PASSWORD screen.

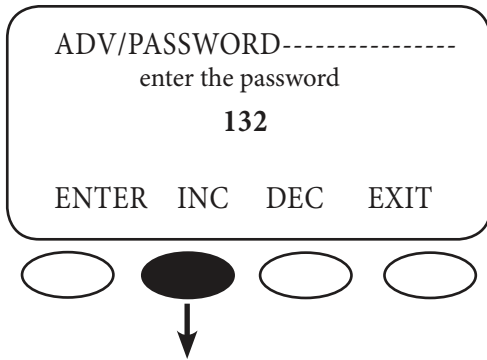

The screen displays 132. Press the **INC** button until it scrolls to the password 141.

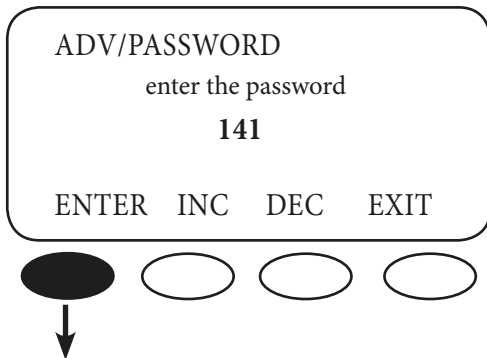

Push **ENTER**.

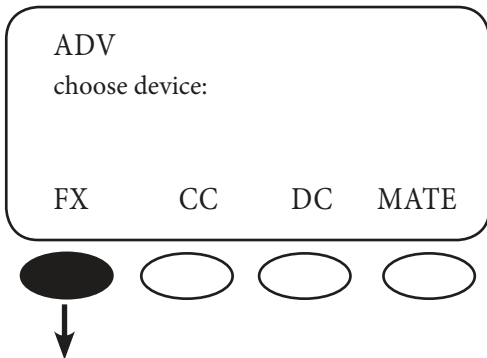

In the ADV menu, press **FX**.

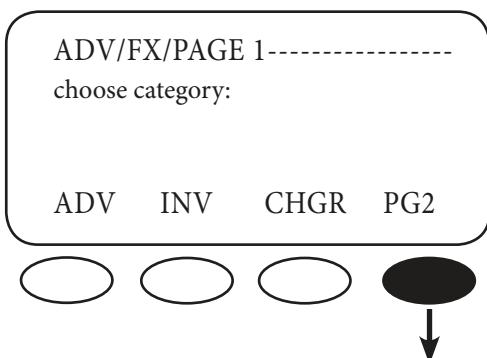

On the ADV/FX/PAGE 1 screen, press **PG2** and go to the ADV/FX/PAGE2 screen.

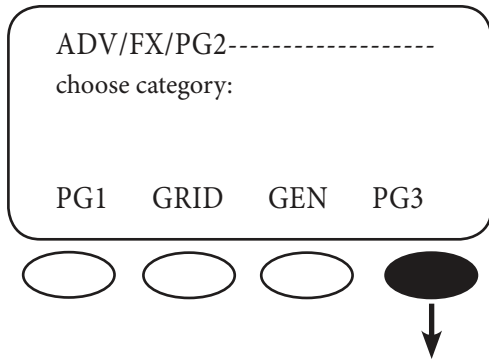

Press **PG3** which leads to the ADV/FX/PAGE3 screen.

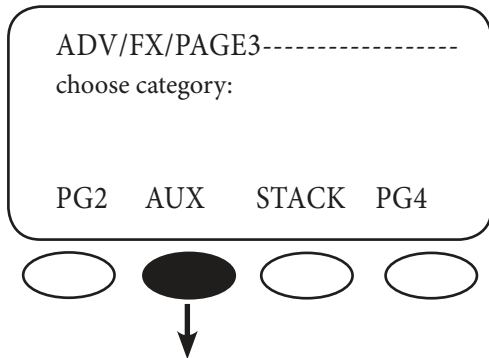

On the ADV/FX/PAGE3 screen, press **AUX** to adjust the AUX output set points and operation.

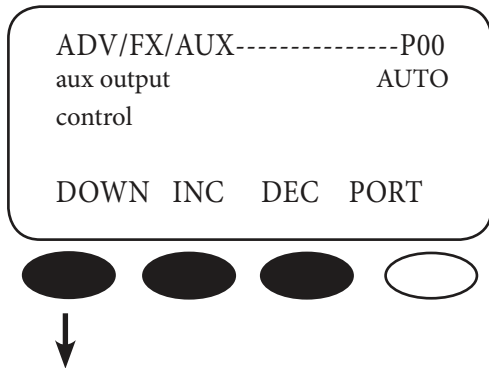

Selecting **INC** or **DEC** changes the mode of the AUX.

- AUTO allows the AUX to perform a selected AUX OUTPUT FUNCTION, determined in the following screens.
- OFF disables the AUX.
- ON activates the AUX regardless of the selected function.

Press **DOWN** to select on an AUX OUTPUT

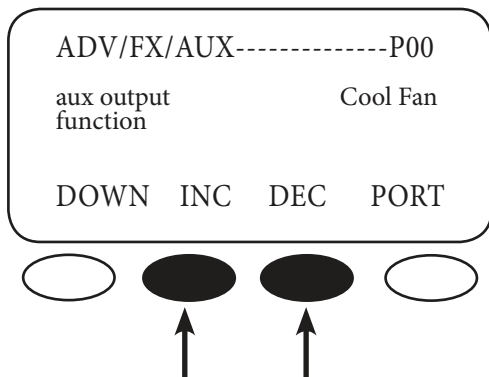

Pressing the **<INC>** or **<DEC>** soft keys changes the aux function.

There are nine AUX OUTPUT FUNCTIONS:

- Cool Fan
- Divert DC
- Divert AC
- AC Drop
- Vent Fan
- Fault
- GenAlert
- Load Shed
- Remote

Pressing either **INC** or **DEC** will bring up another AUX OUTPUT FUNCTION

LIST OF AUX FUNCTIONS

- **Cool Fan** activates the standard TurboFan which cools the FX during an over temperature condition.
- **Divert DC** and **Divert AC** allows the AUX to divert excess renewable energy to a DC or AC load, respectively. This allows control of energy sources such as wind turbines or hydro-generators. When using Divert AC, the AUX output will shut off if the inverter is overloaded.
- **AC Drop** is activated when an AC power source disconnects from an FX. An indicator, such as an alarm, connected to the AUX warns a user that AC power is no longer available.
- **Vent Fan** provides 0.7 amps to run a 12VDC fan for removing hydrogen from the battery compartment. Vent Fan can operate automatically when the VENTFAN ON voltage set point is exceeded or it can operate intermittently by adjusting the VENTFAN OFF PERIOD.
- In **Fault** mode, the AUX can send an alarm signal via radio, pager, or telephone device when the FX enters into an error condition. Fault mode can also be used to log error conditions by triggering an event recording device.
- **GenAlert**, through a 12VDC relay, will tell the system to start a two-wire type generator when the battery voltage falls below a certain set point. GenAlert can be adjusted according to the shortfall-battery voltage, the amount of time spent at this voltage, the recharged voltage and amount of time at this voltage before GenAlert is de-energized.
- **Load Shed** energizes the AUX the reduce the load demand on the batteries and the inverter function, thus acting as a load management system.
- Setting the AUX to **Remote** allows a message sent through the serial Port on the MATE to switch the AUX on and off.
- Note that using Advanced Generator Start (AGS) overrides any programmed AUX function.

Adjustable AUX OUTPUT FUNCTIONS

There are four AUX functions whose settings can be adjusted by the user:

- Diversion
- Vent Fan
- GenAlert
- Load Shed

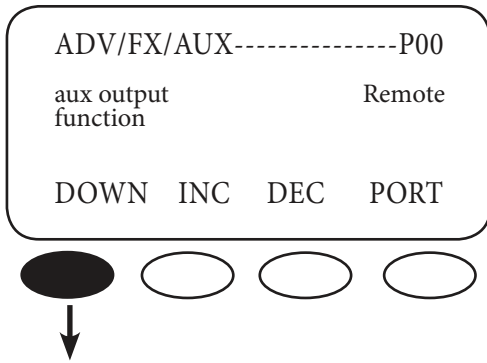

From the remote *aux output function* screen, press **DOWN**. This will bring up the first of several screen used to adjust which ever mode you have chosen for the AUX function.

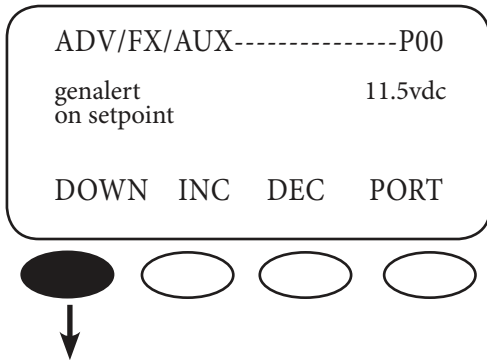

The *genalert on setpoint* screen shows the voltage—whose range is between 10.0VDC and 14.0VDC, adjusted with **INC** and **DEC**—that energizes the AUX in *genalert* mode. Press **DOWN** to view the *genalert on delay* screen.

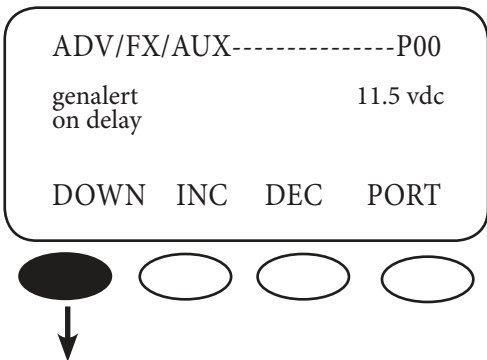

The *genalert on delay* is the amount of time the battery voltage must remain below the *genalert set point* before the AUX is energized. This allows for brief periods of heavy load usage and has a range of 0-240 minutes in one minute increments, adjustable with **INC** and **DEC**. Press **DOWN** to bring up the *genalert off setpoint* screen.

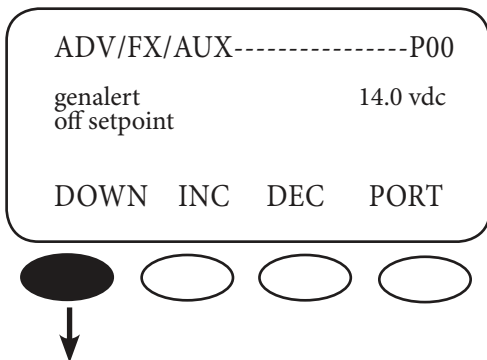

In *genalert* mode, the AUX de-energizes when the *genalert off setpoint* is reached. This setpoint's range is between 12.0VDC and 18.0VDC and is adjusted using **INC** and **DEC**. Press **DOWN** to view the *genalert off delay* screen.

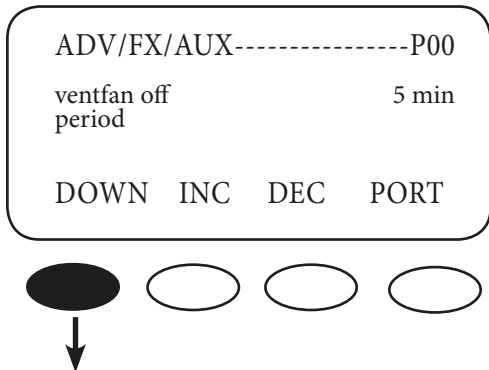
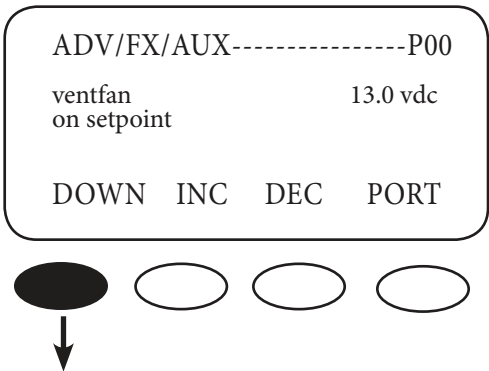
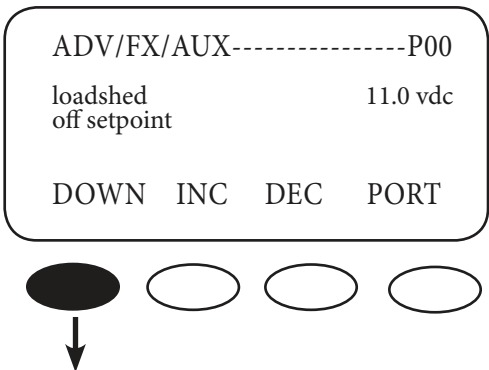
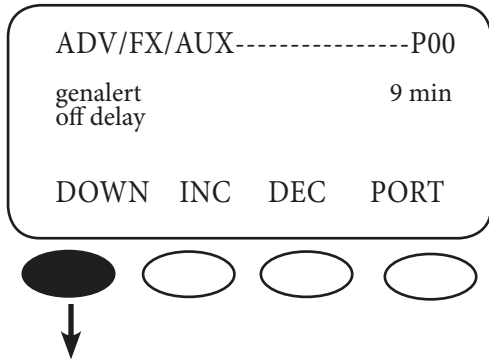

After a battery has recharged or returned to the *genalert off setpoint*, *genalert off delay* determines the amount of time the generator remains on to assure the battery has been more fully recharged. The user can adjust this time from 0-240 minutes using **INC** and **DEC**. Press **DOWN** to view the *loadshed off setpoint* screen.

The *loadshed off setpoint* battery voltage triggers the AUX to reduce the inverter and battery loads. When the battery voltage drops below this value for three seconds, the AUX powers a DC coil relay to disconnect an AC load. Once triggered, *loadshed* remains on for at least three minutes. The *loadshed off setpoint* is adjustable from 10 VDC-14 VDC using **DEC** and **INC**. Press **DOWN** to bring up the *ventfan on setpoint*.

When the AUX is set to *ventfan*, a fan ventilates a battery enclosure. The *ventfan on setpoint* establishes the battery voltage which energizes the AUX and thus the fan for a one minute period. The voltage setting has a range of 10.0 VDC-16.0 VDC using **INC** and **DEC**. Recharging causes batteries to emit mostly hydrogen gas; higher recharging voltages emit more gas. Press **DOWN** to view the *ventfan off period* screen.

If a ventilation fan is only needed intermittently, the *ventfan off period* shuts the fan off for a user-determined time before starting up again for a one-minute period when the battery voltage exceeds the *ventfan on setpoint*. This off period can be set from 0-30 minutes using **INC** and **DEC**. Setting this period to zero will keep the fan running the entire time the battery voltage is high enough to activate the ventfan function. Setting it to five minutes means the fan will run for one minute and then shut off for five minutes until the battery voltage drops and the fan is no longer needed. Press **DOWN** to view the *diversion on setpoint* screen.

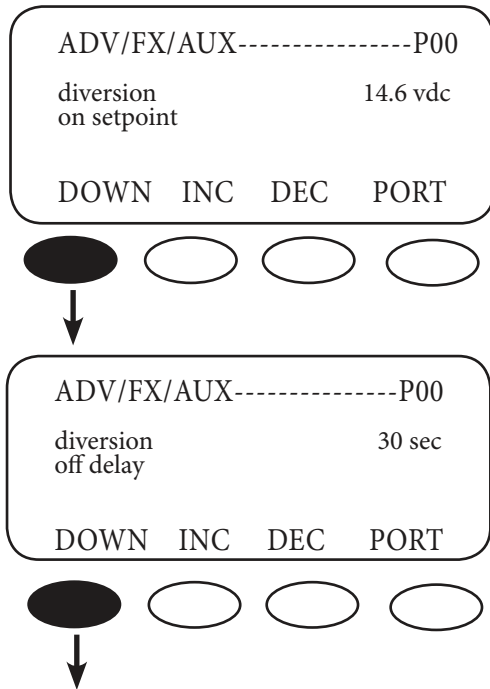

After deciding on Divert DC or Divert AC, use the *diversion on setpoint* screen to choose the voltage which will activate this AUX OUTPUT FUNCTION. This value can range from 12.0VDC-16.0VDC and can be adjusted in 0.1VDC increments using **INC** and **DEC**. Press **DOWN** to view the *diversion off delay* screen.

The *diversion off relay* determines how long the AUX will be energized after the battery voltage which caused the diversion falls below the diversion on setpoint. This relay can range from 0-240 seconds in one-second increments as adjusted with **INC** and **DEC**.

BATTERY CHARGING INSTRUCTIONS

Keeping your battery bank energized is very important. Although a battery bank can last for many years if properly cared for, it can also be ruined in a short period of time if neglected.

Battery Charging Setpoints

To preserve your batteries, always follow your battery manufacturer's recommendations using the following information:

- Absorb Voltage
- Float Voltage
- Equalize Voltage
- Recommended Depth of Discharge (DOD) of the batteries

These Absorb, Float, and Equalize voltage set points should be programmed into the FX through the MATE (see MATE User Manual).

Maintenance

Please contact OutBack Power Systems Technical Services for any FX repairs due to malfunctions or damage. For routine, user-approved maintenance:

- Disconnect all circuit breakers and related electrical connections before doing any cleaning or adjustments.
- Solar modules may produce hazardous voltages when exposed to light; cover them with opaque material before servicing any connected equipment.
- If a remote or automatic generator start system is used, disable the automatic starting circuit and/or disconnect the generator from its starting battery while servicing.

12 VDC System	DEFAULT	MINIMUM	MAXIMUM
Float Voltage	13.6V	12V	15V
Absorb Voltage	14.4V	13V	16V
EQ Voltage	14.4V (24VDC Grit-Tie=29.2)	14V	17V
ReFloat	12.5V	11V	13V
LBCO	10.5V	9V	12V
LBCI	12.5V	10V	14V
Sell RE	13V	10V	15V
Gen Alert			
Off Set Point	14V	12V	18V
On Set Point	11V	10V	14V
Load Shed Off Set Point	11V	10V	14V
Vent Fan ON Set Point	13V	10V	16V
Diversion ON Set Point	14.6V	12V	16V
Absorb Time	1.0 hours	0.0 hours	24.0 hours
EQ Time	1.0 hours	0.0 hours	24.0 hours
Float Time	1.0 hours	0.0 hours	24.0 hours
AC2/Gen Transfer Delay (Cycles for AC)	60 cycles* (*20 for Grid-Tie)	0 cycles	240 cycles
Search	6	0	50
Grid Lower Limit	108V	40V	115V
Grid Upper Limit	140	80V	220V
Grid Upper Limit	140V	130V	150V
Grid Connect Delay	.5 min	.2 min	15.0 min
DROP or USE	USE	N/A	N/A
Charger OFF/AUTO/ON	AUTO		
AUX Output Option	COOL FAN		
Gen Alert ON Delay	4 min	0 min	240 min
Gen Alert OFF Delay	9 min	0 min	240 min
Vent Fan OFF Delay	5 min	0 min	30 min
Gen Window Lower Limit	108V	40V	115V
Gen Upper Window Limit	140V	130V	150V
AC1/Grid Transfer Delay	6 Cycles of AC	0 Cycles of AC	240 Cycles of AC
Set AUX Control	AUTO		
Search Pulses	8	2	20
Search Pulse Spacing	60 Cycles Ac	4 Cycles AC	120 Cycles AC
Stacking Phase	1 or 2 phase		
InPut Select	Master Gen		
Charge Rates			
Vented 24 & 48 VDC	9 AAC	0 AAC	10 AAC
Vented 12 VDC	6 AAC	0 AAC	7 AAC
Sealed 24 & 48 VDC	5 AAC	0 AAC	7 AAC
Sealed 12 VDC	5 AAC	0 AAC	6 AAC
Grid Input Settings			
Set AC Input Size			
Mobile	28 Amp	5 Amp	30 Amp
Non-Mobile U.S.	48 Amp	5	
Grid-Tie	50 Amp		
Gen Input Settings			
Mobile	28 Amp	2Amp	30 Amp
Non-Mobile U.S.	48 Amp	2 Amp	60 Amp
Grid-Tie	50 Amp		
Set VAC	120V (230V Export)	110V GT (210V Export, 105V Off-Grid and Mobile)	125V (240V Export)

Correction Factor
•24VDC: Multiply 12VDC values by 2 •32VDC: Multiply 12VDC values by 2.64 •48VDC: Multiply 12VDC values by 4



TWO YEAR LIMITED WARRANTY INFORMATION

FX Series Inverter/Charger Products

OutBack Power Systems, Inc. ("OutBack") provides a two year (2) limited warranty ("Warranty") against defects in materials and workmanship for its FX/VFX Series Inverter/Charger products ("Product(s)") if installed in fixed location applications.

The term of this Warranty begins on the Product(s) date of manufacture or the initial purchase date as indicated on the warranty registration card submitted to OutBack, whichever is greater. This Warranty applies to the original OutBack Product(s) purchaser, and is transferable only if the Product(s) remains installed in the original use location. The warranty does not apply to any Product(s) or Product(s) part that has been modified or damaged by the following:

- Installation or Removal;
- Alteration or Disassembly;
- Normal Wear and Tear;
- Accident or Abuse;
- Corrosion;
- Lightning;
- Repair or service provided by an unauthorized repair facility;
- Operation contrary to manufacturer product instructions;
- Fire, Floods or Acts of God;
- Shipping or Transportation;
- Incidental or consequential damage caused by other components of the power system;
- Any product whose serial number has been altered, defaced or removed; or
- Any other event not foreseeable by OutBack.

OutBack's liability for any defective Product(s), or any Product(s) part, shall be limited to the repair or replacement of the Product(s), at OutBack's discretion. OutBack does not warrant or guarantee workmanship performed by any person or firm installing its Product(s). This Warranty does not cover the costs of installation, removal, shipping (except as described below), or reinstallation of Product(s).

Revision.2008-04-01

To request warranty service, you must contact OutBack Technical Services at (360) 435-6030 or support@outbackpower.com within the effective warranty period. OutBack Technical Support will attempt to troubleshoot the product and validate that the failure is product related. If warranty service is required, OutBack will issue a Return Material Authorization (RMA) number. A request for an RMA number requires all of the following information:

1. Proof-of-purchase in the form of a copy of the original Product(s) purchase invoice or receipt confirming the Product(s) model number and serial number;
2. Description of the problem; and
3. Shipping address for the repaired or replacement equipment.

After receiving the RMA number, pack the Product(s) authorized for return, along with a copy of the original purchase invoice, in the original Product(s) shipping container(s) or packaging providing equivalent protection and mark the outside clearly with the RMA number. The sender must prepay all shipping charges to the agreed upon OutBack Power Systems location, and insure the shipment, or accept the risk of loss or damage during shipment. OutBack is not responsible for shipping damage caused by improperly packaged Products, the repairs this damage might require, or the costs of these repairs. If, upon receipt of the Product(s), OutBack determines the Product(s) is defective and that the defect is covered under the terms of this Warranty, OutBack will then and only then ship a repaired or replacement Product(s) to the purchaser freight prepaid, non-expedited, using a carrier of OutBack's choice, where applicable.

The warranty period of any repaired or replacement Product is twelve (12) months from the date of shipment from OutBack, or the remainder of the initial warranty term, which ever is greater.

THIS LIMITED WARRANTY IS THE EXCLUSIVE WARRANTY APPLICABLE TO OUTBACK PRODUCTS. OUTBACK EXPRESSLY DISCLAIMS ANY OTHER EXPRESS OR IMPLIED WARRANTIES OF ITS PRODUCTS, INCLUDING BUT NOT LIMITED TO ANY IMPLIED WARRANTIES OF MERCHANTABILITY OR FITNESS FOR A PARTICULAR PURPOSE. OUTBACK ALSO EXPRESSLY LIMITS ITS LIABILITY IN THE EVENT OF A PRODUCT DEFECT TO REPAIR OR REPLACEMENT IN ACCORDANCE WITH THE TERMS OF THIS LIMITED WARRANTY AND EXCLUDES ALL LIABILITY FOR INCIDENTAL OR CONSEQUENTIAL DAMAGES, INCLUDING WITHOUT LIMITATION ANY LIABILITY FOR PRODUCTS NOT BEING AVAILABLE FOR USE OR LOST REVENUES OR PROFITS, EVEN IF IT IS MADE AWARE OF SUCH POTENTIAL DAMAGES. SOME STATES (OR JURISDICTIONS) MAY NOT ALLOW THE EXCLUSION OR LIMITATION OF WARRANTIES OR DAMAGES, SO THE ABOVE EXCLUSIONS OR LIMITATIONS MAY NOT APPLY TO YOU.

Revision.2008-04-01



Limited Warranty Registration

Complete this form to request a Limited Warranty, and return it to:

Outback Power Systems Inc.
19009 62nd Ave. NE
Arlington, WA 98223

NOTE: Please submit a copy (not the original) of the Product purchase invoice, which confirms the date and location of purchase, the price paid, and the Product Model and Serial Number.

Two Year Limited FX Warranty Registration

System Owner

Name: _____ Country: _____
Address: _____ Telephone Number: _____
City, State, Zip Code: _____ E-mail: _____

Product

Product(s) Model Number(s): _____ Sold by: _____
Product(s) Serial Number(s): _____ Purchase Date: _____

Please circle the three most important factors affecting your purchase decision:

- Price
- Product Reputation
- Product Features
- Reputation of OutBack Power Systems
- Value

System

System Install/Commission Date: _____ Total Nominal System AC Output in KW: _____
Nominal System AC Voltage: _____ System Battery Bank Size (Amp Hours): _____
Type of Batteries: _____

Are you using a generator with this system? (Circle One): Yes No

If yes, please list the make and model: _____

If yes, is the generator's output is (Circle One): AC DC

Installer

Name (If Applicable): _____ Address: _____
City, State, Zip: _____ E-mail: _____
Contractor Number: _____

*Extended Warranty

OutBack Power Systems offers an optional three (3) year extension to the standard two (2) year Limited Warranty for the FX/VFX Series Inverter/Charger product. To request a 3-year Limited Warranty extension for a total effective warranty coverage period of five (5) years; include a check or money order in the amount of \$300USD payable to OutBack Power Systems, Inc. along with your Warranty Registration.

Revision.2008-04-01



19009 62nd Avenue NE
Arlington, WA 98223 USA
(+1) 360.435.6030

European Sales Office
Barcelona, ESPAÑA
(+34) 600.843.845

www.outbackpower.com

900-0086-01-00 REV B